



INSTRUCTION MANUAL

VHF MOBILE TRANSCEIVER
IC-F5022
UHF MOBILE TRANSCEIVER
IC-F6022

MDC 1200
Compatible



Icom Inc.

IMPORTANT

READ ALL INSTRUCTIONS carefully and completely before using the transceiver.

SAVE THIS INSTRUCTION MANUAL — This instruction manual contains important operating instructions for the **IC-F5022 VHF MOBILE TRANSCEIVER** and the **IC-F6022 UHF MOBILE TRANSCEIVER**.

EXPLICIT DEFINITIONS

WORD	DEFINITION
 WARNING!	Personal injury, fire hazard or electric shock may occur.
CAUTION	Equipment damage may occur.
NOTE	If disregarded, inconvenience only. No risk of personal injury, fire or electric shock.

Icom, Icom Inc. and the Icom logo are registered trademarks of Icom Incorporated (Japan) in Japan, the United States, the United Kingdom, Germany, France, Spain, Russia and/or other countries.

All other products or brands are registered trademarks or trademarks of their respective holders.

PRECAUTIONS

⚠ **WARNING! NEVER** connect the transceiver to an AC outlet. This may pose a fire hazard or result in an electric shock.

⚠ **WARNING! NEVER** connect the transceiver to a power source of more than 16 V DC such as a 24 V battery. This connection will ruin the transceiver.

⚠ **WARNING! NEVER** cut the DC power cable between the DC plug and fuse holder. If an incorrect connection is made after cutting, the transceiver might be damaged.

⚠ **WARNING! NEVER** place the transceiver where normal operation of the vehicle may be hindered or where it could cause bodily injury.

CAUTION: NEVER allow children to touch the transceiver.

CAUTION: NEVER expose the transceiver to rain, snow or any liquids.

USE the specified microphone only. Other microphones have different pin assignments and may damage the transceiver.

DO NOT use or place the transceiver in areas with temperatures below -25°C or above $+55^{\circ}\text{C}$, or in areas subject to direct sunlight, such as the dashboard.

DO NOT operate the transceiver without running the vehicle's engine. The vehicle's battery will quickly run out when the transceiver transmits while the vehicle's engine is OFF.

DO NOT place the transceiver in excessively dusty environments.

DO NOT place the transceiver against walls. This will obstruct heat dissipation.

DO NOT use chemical agents such as benzine or alcohol when cleaning, as they damage the transceiver surfaces.

BE CAREFUL! The transceiver will become hot when operating continuously for long periods.

Approved Icom optional equipment is designed for optimal performance when used with an Icom transceiver. Icom is not responsible for the destruction or damage to an Icom transceiver in the event the Icom transceiver is used with equipment that is not manufactured or approved by Icom.

TABLE OF CONTENTS

IMPORTANT	i	3 CONNECTION AND MAINTENANCE	14–16
EXPLICIT DEFINITIONS	i	■ Rear panel connection	14
PRECAUTIONS	ii	■ Supplied Accessories	15
TABLE OF CONTENTS	iii	■ Mounting the transceiver	15
1 PANEL DESCRIPTION.....	1–6	■ Antenna	16
■ Front panel	1	■ Fuse replacement	16
■ Function display	2	■ Cleaning	16
■ Programmable function keys	3	■ Options	16
2 BASIC OPERATION.....	7–13	4 COUNTRY CODE LIST	17
■ Turning power ON	7		
■ Channel selection.....	7		
■ Call procedure	8		
■ Receiving and transmitting	8		
■ User set mode	11		
■ Emergency transmission	11		
■ Scrambler function	12		
■ Priority A channel selection	12		
■ Stun function	12		
■ MDC 1200 system operation.....	13		

■ Front panel

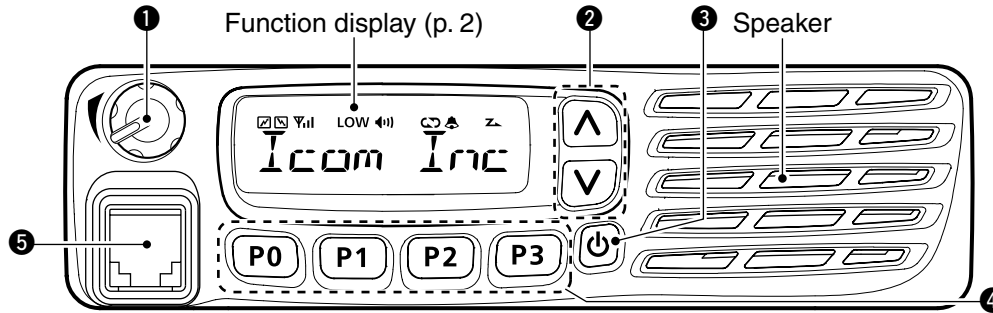

1 AF VOLUME CONTROL KNOB [VOL]

Rotate the knob to adjust the desired audio output level.

- Minimum audio level is pre-set. (p. 11)

2 UP/DOWN KEYS [CH Up]/[CH Down]

Push to select an operating channel, etc.

- * The desired function can be assigned by your dealer. (p. 3)

3 POWER KEY [⏻]

Push to turn the power ON and OFF.

- The following functions are available at power ON as options:
 - Automatic scan start
 - Password prompt
 - Set mode

4 DEALER-PROGRAMMABLE KEYS

Desired functions can be programmed independently by your dealer. (p. 3)

5 MICROPHONE CONNECTOR

Connect the supplied or optional microphone.

- NEVER connect non-specified microphones. The pin assignments may be different and the transceiver may be damaged.

◇ MICROPHONE

The supplied or optional microphone has a PTT switch and a hanger hook.

- The following functions are available when the microphone is on or off hook (depending on the setting):
 - Automatic scan starts when it is on hook.
 - Scan is cancelled when it is off hook.
 - Scan is paused when it is off hook.
 - Automatic priority channel selection is available when it is off hook.
 - Sets to 'Inaudible' condition (mute condition) when it is on hook.
 - Sets to 'Audible' condition (unmute condition) when it is off hook.

1 PANEL DESCRIPTION

■ Function display

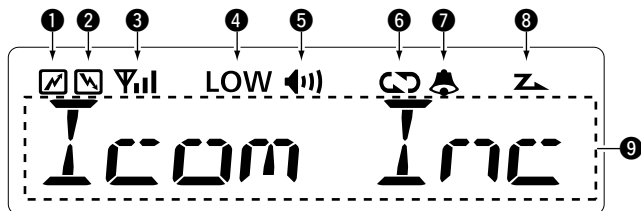

1 TRANSMIT INDICATOR

Appears while transmitting.

2 BUSY INDICATOR

Appears while the channel is busy.

3 SIGNAL STRENGTH INDICATOR

Indicates relative signal strength level as below.



Weak \Leftarrow Receive Signal level \Rightarrow Strong

4 LOW POWER INDICATOR

Appears when low output power is selected.

5 AUDIBLE INDICATOR

➔ Appears when the channel is in the 'Audible' (unmute) condition.

➔ Appears when the specific 2/5-tone/MDC* code is received.

6 SCRAMBLER INDICATOR

Appears when the voice scrambler function is activated.

7 BELL INDICATOR

Appears/blinks when the specific 2/5-tone/MDC* code is received, according to the pre-programming.

8 SCAN INDICATOR

Blinks during scan.

9 ALPHANUMERIC DISPLAY

Displays an operating channel number, channel name, Set mode contents, DTMF code, etc.

* MDC operation only (p. 13)

■ Programmable function keys

The following functions can be assigned to [UP], [DOWN], [P0], [P1], [P2] and [P3] programmable function keys.

Consult your loom dealer or system operator for details concerning your transceivers programming.

If the programmable function names are bracketed in the following explanations, the specific key is used to activate the function depends on the programming.

CH UP AND DOWN KEYS

- Push to select an operating channel.
- Push to select a transmit code channel after pushing [TX Code CH Select].
- Push to select a DTMF channel after pushing [DTMF Audial].
- Push to select a scan group after pushing and holding [Scan A Start/Stop]/[Scan B Start/Stop] for 1 sec.

ZONE KEY

Push this key, then select the desired zone using [CH Up]/[CH Down].

What is “zone”?— Selected channels are assigned to a zone according to how they are to be used in a group. For example, ‘Staff A’ and ‘Staff B’ are assigned into a “Business” zone, and ‘John’ and ‘Cindy’ are assigned into a “Private” zone.

SCAN A START/STOP KEY

- Push to start and cancel scanning operation.
 - When Power ON Scan function is activated, push to pause the scanning operation. And the paused scan resumes after the specified time period has passed.
- Push and hold this key for 1 sec. to indicate the scan list, then push [CH Up] or [CH Down] to select the desired list.

SCAN B START/STOP KEY

- Push to start and cancel scanning operation. The scan restarts after the specified time period has passed when the scan (started with this key) is cancelled by except for this key operation.
- Push and hold this key for 1 sec. to indicate the scan list, then push [CH Up] or [CH Down] to select the desired list.

SCAN ADD/DEL (TAG) KEY

- Push to add/delete the selected channel to/from the scan list.
 1. Push to indicate the scan group, then push [CH Up] or [CH Down] to select the desired list.
 2. Push to add or delete the channel to/from the selected scan list.
 3. Push and hold for 1 sec. to exit the scan list selection mode.
- Push this key while scan is paused (a signal is detected) on a channel (except for priority channel), the channel is cleared from the scan list.

Depending on the setting, the cleared channel is added to the scan list again after the scan is cancelled.

1 PANEL DESCRIPTION

PRIO A/B KEYS

- Push to select Priority A or Priority B channel.
- Push and hold [Prio A (Rewrite)] or [Prio B (Rewrite)] for 1 sec. to rewrite the operating channel as the Priority A or Priority B channel.

MR-CH 1/2/3/4 KEYS

Push to select the memory channel 1 to 4 directly.

MONI (AUDI) KEY

- Push to mute and release the CTCSS (DTCS) or 2-tone squelch mute. Open any squelch/deactivate any mute while pushing and holding this key. (LMR operation only)
- Activates one of (or two of) the following functions on each channel independently: (PMR operation only)
 - Push and hold to unmute the channel (audio is emitted; 'Audible' condition).
 - Push to mute the channel (sets to 'Inaudible' only).
 - Push after the communication is finished to send a 'reset code'. (5-tone operation only)

 **NOTE:** The un-mute condition ('Audible' condition) may automatically return to the mute condition ('Inaudible' condition) after a specified period depending on programming.

LOCK KEY

Push and hold to electronically lock all programmable keys except the following:

[Moni(Audi)], [Lock], [Call] (incl. Call A and Call B), [Emergency], [Surveillance], [Siren], [Lone Worker] and [OPT 1/2/3].

LONE WORKER KEY

Push to turn the Lone Worker function ON or OFF.

- If the Lone Worker function is activated, Emergency function is automatically turned ON after the specified time period has passed with no operation is performed.

HIGH/LOW KEY

Push to select the transmit output power temporarily or permanently, depending on the pre-setting.

- Ask your dealer for the output power level for each selection.

C.TONE CH ENT KEY

Push to enter the continuous tone channel selection mode. Then, push [CH Up]/[CH Down] to change the tone frequency/code setting. The selected channel remains set as the continuous tone channel until another channel is designated as such.

TALK AROUND KEY

Push to turn the talk around function ON and OFF.

- The talk around function equalizes the transmit frequency to the receive frequency for transceiver-to-transceiver communication.

WIDE/NARROW KEY

Push to toggle the IF bandwidth between wide and narrow.

- The wide passband width can be selected from 25.0 or 20.0 kHz using the CS-F3020/F5020 CLONING SOFTWARE. (PMR operation only) Ask your dealer for details.

DTMF AUTODIAL KEY

- Push to enter the DTMF channel selection mode. And then select the desired DTMF channel using [CH Up]/[CH Down].
- After selecting the DTMF channel, push again to transmit the selected DTMF code.

RE-DIAL KEY

Push to transmit the last-transmitted DTMF code.

- TX memories are cleared after turning the transceiver OFF.

CALL KEYS

Push to transmit a 2/5-tone ID code.

- Call transmission is necessary before calling another station depending on your signalling system.
- [Call A] and/or [Call B] may be available when your system employs selective 'Individual/Group' calls. Ask your dealer which call is assigned to each key.

EMERGENCY KEY

Push and hold this for specified period to transmit an emergency call.

- The emergency call transmits with beeps; the display does not change.
- The transceiver can transmit an emergency call with no beep emission and LCD indication change depending on the pre-setting. Ask your dealer for details.
- If you want to cancel the emergency call, push and hold the key again before transmitting the call.
- The emergency call is transmitted one time only or repeatedly until receiving a control code, depending on the pre-setting.

SURVEILLANCE KEY

Push to turn the surveillance function ON or OFF.

When this function is turned ON, the beep is not emitted and the LCD backlight does not light when a signal is received or a key is pushed, etc.

SIREN

Push to emit a siren.

TX CODE ENTER KEY (PMR operation only)

Push to enter the TX code edit mode directly.

Then set the desired digit using [CH Up]/[CH Down]. (p. 10)

1 PANEL DESCRIPTION

TX CODE CHANNEL SELECT KEY

- ➔ Push to enter the TX code channel selection mode. Then set the desired channel using [CH Up]/[CH Down]. (p. 9)
- ➔ While in the TX code channel selection mode, push and hold this key for 1 sec. to enter the TX code edit mode. Then set the desired digit using [CH Up]/[CH Down]. (p. 10)

TX CODE CHANNEL UP/DOWN KEYS

Push to select a TX code channel directly.

ID-MR SELECT KEY (PMR operation only)

- ➔ Recalls detected ID codes.
 - Push this key, then select the ID code using [CH Up]/[CH Down].
 - Up to 5 ID's are memorized.
- ➔ Push and hold this key for 1 sec. to erase the selected ID's.

SCRAMBLER KEY

- ➔ Push to turn the voice scrambler function ON and OFF.

USER SET MODE KEY

- ➔ Push and hold for 1 sec. to enter user set mode.
 - During user set mode, push this key to select an item*, and change the value or condition using [CH Up]/[CH Down].
*Selectable items may differ depending on the pre-setting.
- ➔ Push and hold this key for 1 sec. again to exit user set mode.

OPT 1/2/3 OUT KEYS

Push to control the output signal level from the optional unit connector.

OPT 1/2/3 MOMENTARY KEYS

Control the output signal level from the optional unit connector while pushing and holding this key.

Ext. CH Sel Mode KEY

- Push to turn the Ext. CH Select function ON or OFF. When the function is turned ON, memory channels can be selected with external input operation only. When the function is turned OFF, memory channels can be selected with [CH Up] or [CH Down] operation, and cannot with external input operation.
- This function is available when the external unit, such as a dimmer control is connected to the transceiver with an optional cable, OPC-1939 (p. 16).
 - Ask your dealer for details of external input operation.

■ Turning power ON

- ① Push [⏻] to turn the power ON.
- ② If the transceiver is programmed for a start up password, input the digit codes as directed by your dealer.
 - The keys as below can be used for password input:
The transceiver detects numbers in the same block as identical. Therefore “01234” and “56789” are the same.

KEY	P0	P1	P2	P3	V
NUMBER	0	1	2	3	4
	5	6	7	8	9

- ③ When the “PASSWORD” indication does not clear after inputting 4 digits, the input code number may be incorrect. Turn the power off and start over in this case.

■ Channel selection

Several types of channel selections are available. Methods may differ according to your system set up.

NON-ZONE TYPE:

Push [CH Up] or [CH Down] to select the desired operating channel, in sequence; or, push one of [MR-CH 1] to [MR-CH 4] keys to select a channel directly.

ZONE TYPE:

Push [Zone], then push [CH Up] or [CH Down] to select the desired zone.

AUTOMATIC SCAN TYPE:

Channel setting is not necessary for this type. When turning power ON, the transceiver automatically starts scanning. Scanning stops when receiving a call.

2 BASIC OPERATION

■ Call procedure

When your system employs tone signaling (excluding CTCSS and DTCS), a call procedure may be necessary prior to voice transmission. The tone signalling employed may be a selective calling system which allows you to call specific station(s) only and prevents unwanted stations from contacting you.

- ① Select the desired TX code channel, 2/5-tone code according to your System Operator's instructions.
 - This may not be necessary depending on programming.
 - Refer to pages 9–10 for selection.
- ② Push [Call] (assigned to one of the dealer programmable keys).
- ③ After transmitting, the remainder of your communication can be carried out in the normal fashion.

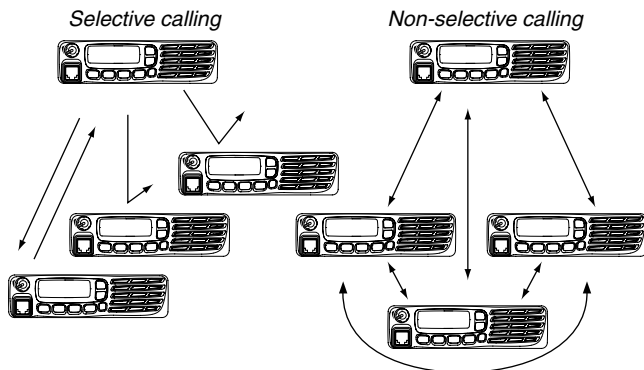

■ Receiving and transmitting

Receiving:

- ① Push and hold [⏻] for 1 sec. to turn the power ON.
- ② Push [CH Up] or [CH Down] to select a channel, in sequence.
- ③ When receiving a call, rotate [VOL] to adjust the audio output level to a comfortable listening level.

NOTE: Depending on the pre-setting, the transceiver automatically transmits the microphone audio for the specified time period* when a matched RX code signal is received.

- HM-148G or HM-152 HAND MICROPHONE is required.

* Depending on the pre-setting. Ask your dealer for details.

Transmitting:

Wait for the channel to become clear to avoid interference.

- ① Take the microphone off hook.
 - The 'audible' condition is selected.
 - A priority channel may be selected automatically.
- ② Wait for the channel to become clear.
 - The channel is busy when BUSY indicator appears on the LCD.
- ③ While pushing and holding [PTT], speak into the microphone at your normal voice level.
- ④ Release [PTT] to return to receive.

IMPORTANT: To maximize the readability of your signal;

1. Pause briefly after pushing [PTT].
2. Hold the microphone 5 to 10 cm (2 to 4 inches) from your mouth, then speak into the microphone at a normal voice level.

◇ Transmitting notes

• Transmit inhibit function

The transceiver has several inhibit functions which restrict transmission under the following conditions:

- The channel is in mute condition ('Inaudible' condition; "🔇") (Audible indicator) does not appear.)
- The channel is busy.
- Un-matched (or matched) CTCSS is received.
(Depending on the pre-setting)
- The selected channel is a 'receive only' channel.

• Time-out timer

After continuous transmission for the pre-programmed time period, the time-out timer is activated, causing the transceiver to stop transmitting.

• Penalty timer

Once the time-out timer is activated, transmission is further inhibited for a period determined by the penalty timer.

• PTTID call

The transceiver sends the ID code (5-tone, DTMF or digital ANI) automatically when [PTT] is pushed (beginning of the transmission) and/or released (end of transmission) depending on the setting.

PTTID call is also available with the MDC 1200 signaling system. (p. 13)

◇ TX code channel selection

If the transceiver has [TX Code CH Select] assigned to it, the indication can be toggled between the operating channel number (or name) and TX code channel number (or name). When the TX code channel number (or name) is displayed, [CH Up] or [CH Down] selects the TX code channel.

USING [TX CODE CH SELECT] KEY:

- ① Push [TX Code CH Select]— a TX code channel number (or name) appears.
- ② Push [CH Up] or [CH Down] to select the desired TX code channel.
- ③ After selecting, push [TX Code CH Select] to set.
 - Return to the stand-by mode.
- ④ Push [Call] to transmit the selected TX code.

USING [TX CODE CH UP]/[TX CODE CH DOWN] KEY:

If the transceiver has a [TX Code CH Up] or [TX Code CH Down] key assignment, the programmed TX code channel can be selected directly when pushed.

2 BASIC OPERATION

◇ TX code number edit (PMR operation only)

If the transceiver has [TX Code CH Select] or [TX Code Enter] assigned to it, TX code contents can be edited within the allowable digits.

USING [TX CODE CH SELECT] KEY:

- ① Push [TX Code CH Select] to enter the TX code channel selection mode.
 - Select the desired operating channel before entering the TX code channel selection mode if necessary.
- ② Push [TX Code CH Select] for 1 sec. to enter the TX code edit mode.
 - The digit to be edited blinks.
- ③ Push [TX Code CH Select] to select the desired digit to be edited.
- ④ Push [CH Up] or [CH Down] to select the desired digit.
- ⑤ Push [TX Code CH Select] to set. The digit to the right will blink automatically.
- ⑥ Repeat ④ and ⑤ to edit all allowable digits.
- ⑦ After editing, push [TX Code CH Select] to set.
 - Return to the stand-by mode.
- ⑧ Push [Call] to transmit.

USING [TX CODE ENTER] KEY:

- ① Push [TX Code Enter] to enter the TX code edit mode.
 - The digit to be edited blinks.
- ② Push [TX Code Enter] to select the desired digit to be edited.
- ③ Push [CH Up] or [CH Down] to select the desired digit.
- ④ Push [TX Code Enter] to set. The digit to the right will blink automatically.
- ⑤ Repeat ③ and ④ to edit all allowable digits.
- ⑥ After editing, push [TX Code Enter] to set.
 - Return to the stand-by mode.
- ⑦ Push [Call] to transmit.

◇ DTMF transmission

If the transceiver has [DTMF Autodial] assigned to it, the automatic DTMF transmission function is available. Up to 8 DTMF channels are available.

- ① Push [DTMF Autodial]— a DTMF channel appears.
- ② Push [CH Up] or [CH Down] to select the desired DTMF channel.
- ③ Push [DTMF Autodial] to transmit the DTMF code.

■ User Set mode

If the transceiver has [User Set Mode] assigned to it, you can “customize” the transceiver operation to suit your preferences and operating style.

Entering the User Set mode:

- ① Push and hold [User Set Mode] for 1 sec. to enter the User Set mode.
- ② Push [P0] to select the appropriate item.
Then push [P2] or [P3] to set the desired value or option.
 - In the User Set mode, the selectable items are preset by your dealer. The presetable items are **Backlight, Beep, Beep Level, SQL Level, AF Min Level, Mic Gain, Horn, Battery Voltage, Signal Moni** and **Lone Worker**.
- ③ Push and hold [User Set Mode] for 1 sec. again to exit the User Set mode.

■ Emergency transmission

The emergency call can be performed using [Emergency]. (p. 5)
When [Emergency] is pushed for the specified time period, the DTMF or 5-tone emergency signal is transmitted once or repeatedly on the emergency channel depending on the channel. However, when no emergency channel is specified, the signal is transmitted on the previously selected channel.

If you want to cancel the emergency call, push and hold the key again before transmitting the call.



Emergency call is also available with the MDC 1200 signaling system. (p. 13)

2 BASIC OPERATION

■ Scrambler function

The voice scrambler function provides private communication between stations.

The optional Rolling or Non-rolling type can be available.

- ① Push [Scrambler] to turn the scrambler function ON.
 - “” (Scrambler indicator) appears.
- ② Push [Scrambler] again to turn the scrambler function OFF.
 - “” disappears.

■ Priority A channel selection

When one of the following operations is performed, the transceiver selects the Priority A channel automatically.

- Turning the power ON
The Priority A channel is selected each time the transceiver power is turned ON.
- Off hook.
The Priority A channel is selected when the microphone is took off from its hanger.

■ Stun function

When the specified ID, set as a stun ID or kill ID, is received, the stun function is activated.

When the stun ID is received, the transceiver becomes unusable. Entering of the password (p. 8) or receiving a specified ID, set as a revive ID, is necessary to operate the transceiver again in this case.

When the kill ID is received, the transceiver switches to the cloning required condition. Cloning the transceiver is necessary to operate the transceiver again in this case.

Stun function is also available with the MDC 1200 signaling system. (p. 13)

■ MDC 1200 system operation

The MDC 1200 signaling system enhances your transceiver's capabilities. It allows PTT ID*, Emergency signaling, and receiving Radio Check. Also, the dispatcher can stun and revive transceivers on the system.

An additional feature of MDC 1200 system found in Icom transceivers is called aliasing. Each transceiver on the system has a unique ID number. Aliasing allows the substitution of an alphanumeric name for this ID number. For transmit, you can use this alias to select a transceiver to call. For receive, the alias of the calling station is displayed instead of the ID.

*When [PTT] is pushed and/or released, the transceiver transmits your own station ID.

◇ Receiving an Emergency Call

- ① When an emergency call is received;
 - Beeps sound.
 - The calling station ID (or alias) and "EMG EMG" are displayed alternately.

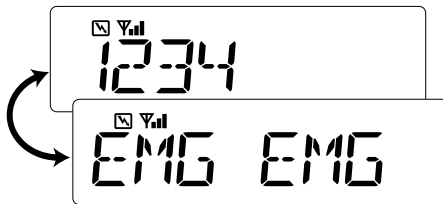

- ② Turn power OFF, change the channel, push [PTT] for replying the call, etc. to stop the beep and display indication.

◇ Transmitting an Emergency Call

The MDC 1200 system Emergency feature can be accessed using the [Emergency] key (p. 5). The transceiver will send an Emergency MDC 1200 system command once or repeatedly for a programmed number of times until it receives the acknowledgement signal.

The emergency call can be transmitted without a beep emission, and the LCD indication change depends on how emergency is programmed. Ask your dealer for details.

◇ Receiving a Stun and Revive

The dispatcher can send MDC 1200 system signals that will stun or revive your transceiver. If a Stun command is received that matches your station ID, the transceiver will display "SORRY" (default) and you can not receive or transmit. When a Revive command is received that matches your station ID, normal operation is restored.







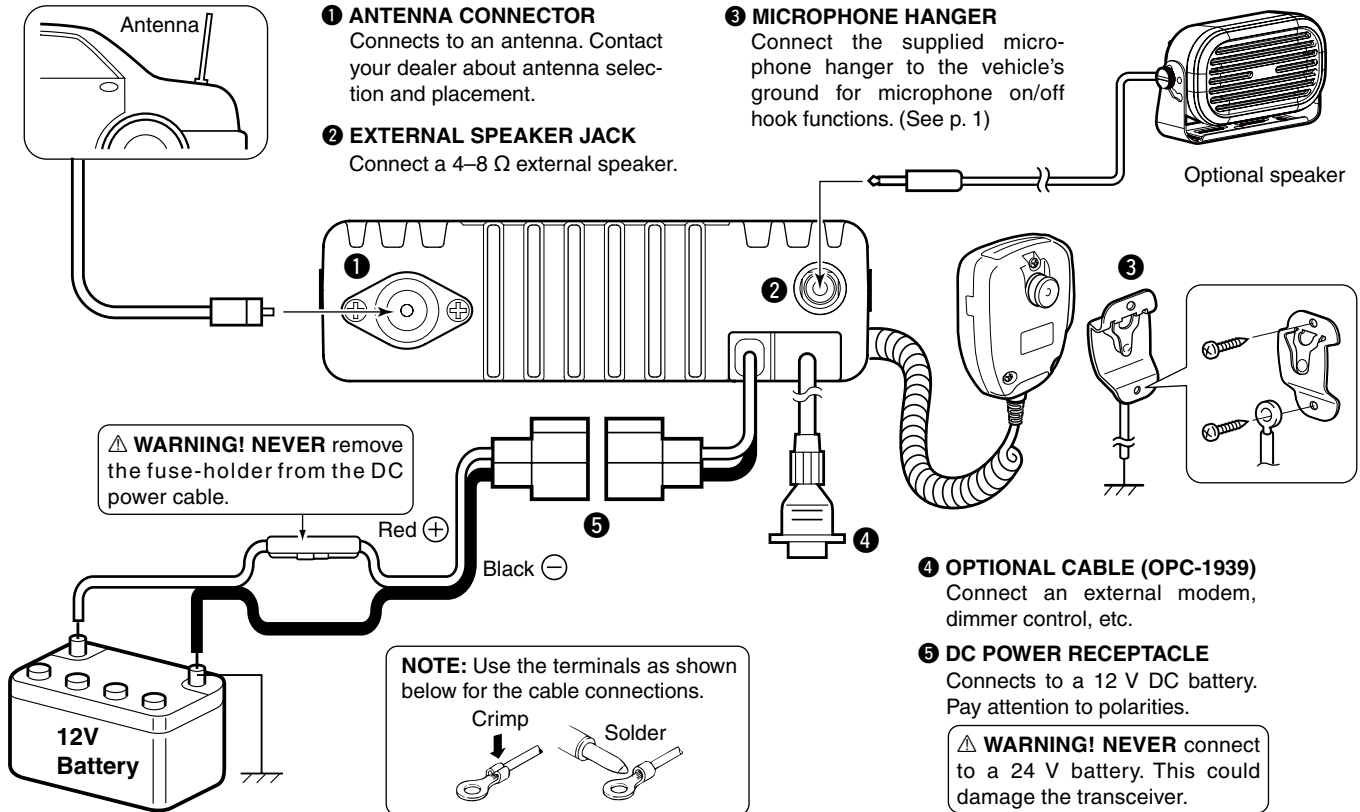

3

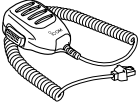
CONNECTION AND MAINTENANCE

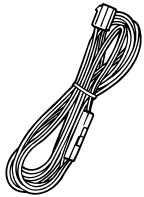
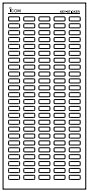
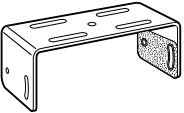
■ Rear panel connection



■ Supplied Accessories

<p>Microphone</p> 	<p>Microphone hanger and screw set</p> 	<p>Microphone hanger cable</p> 
<p>DC power cable</p> 	<p>Function name stickers*</p> 	<p>Mounting bracket</p> 
<p>Flat washers</p> 	<p>Nuts</p> 	<p>Mounting screws (M5×12)</p> 
<p>Spring washers</p> 	<p>Bracket bolts</p> 	<p>Self-tapping screws (M5×20)</p> 

*Used for labelling the programmable function keys according to their assigned functions.

■ Mounting the transceiver

The universal mounting bracket supplied with your transceiver allows overhead mounting.

- Mount the transceiver securely with the 4 supplied screws to a thick surface which can support more than 1.5 kg.

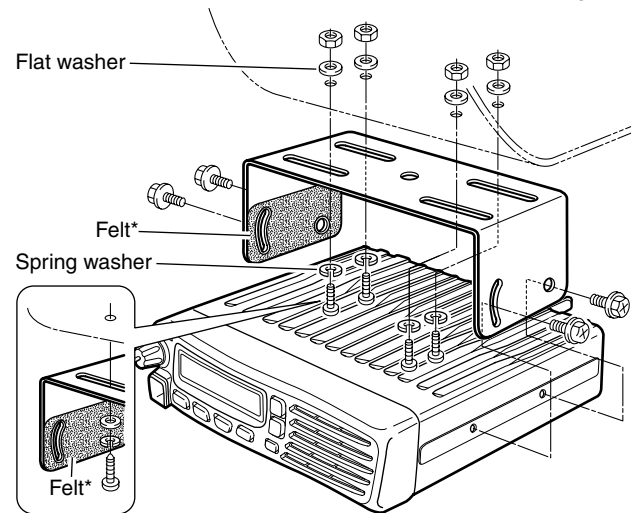

When using self-tapping screws

*Felts reduce the vibration effects.

3 CONNECTION AND MAINTENANCE

■ Antenna

A key element in the performance of any communication systems is an antenna. Contact your dealer for more information regarding antennas and how to install them.

■ Fuse replacement

A fuse is installed in the supplied DC power cable. If a fuse blows or the transceiver stops functioning, track down the source of the problem if possible, and then replace the damaged fuse with a new rated one.

□ Fuse rating: 10 A

USE the 10 A fuse only.

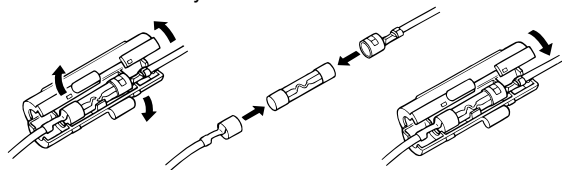

■ Cleaning

If the transceiver becomes dusty or dirty, wipe it clean with a soft, dry cloth.



DO NOT use solvents such as benzene or alcohol, as they may damage the transceiver surfaces.

■ Options

- **OPC-1939** ACC CABLE
Allows you to connect to an external terminal.
- **HM-152/HM-152T/HM-148G/HM-148T** HAND MICROPHONE
 - HM-152 : Hand microphone
 - HM-152T : DTMF microphone
 - HM-148G : Self ground heavy duty microphone
 - HM-148T : Self ground heavy duty microphone with 10-keypad
The 10-keypad of this microphone can be used for the DTMF code transmission only.
- **SM-25** DESKTOP MICROPHONE
- **SP-5/SP-10/SP-35** EXTERNAL SPEAKER
 - Input impedance : 4 Ω
 - Maximum input power : 5 W (SP-5/SP-10) / 7 W (SP-35)
 - SP-5 : Large speaker for good audio quality.
 - SP-10 : For all-round mobile operation.
 - SP-35 : Compact and easy-to-install.
- **UT-108R** DTMF DECODER UNIT
Provides pager and code squelch capabilities.
- **UT-109R/UT-110R** SCRAMBLER UNITS
Non-rolling type (UT-109R)/Rolling type (UT-110R) voice scrambler unit provides higher communication security.

• ISO 3166-1

	Country	Codes		Country	Codes
1	Austria	AT	18	Liechtenstein	LI
2	Belgium	BE	19	Lithuania	LT
3	Bulgaria	BG	20	Luxembourg	LU
4	Croatia	HR	21	Malta	MT
5	Czech Republic	CZ	22	Netherlands	NL
6	Cyprus	CY	23	Norway	NO
7	Denmark	DK	24	Poland	PL
8	Estonia	EE	25	Portugal	PT
9	Finland	FI	26	Romania	RO
10	France	FR	27	Slovakia	SK
11	Germany	DE	28	Slovenia	SI
12	Greece	GR	29	Spain	ES
13	Hungary	HU	30	Sweden	SE
14	Iceland	IS	31	Switzerland	CH
15	Ireland	IE	32	Turkey	TR
16	Italy	IT	33	United Kingdom	GB
17	Latvia	LV			

About e-marking: Detailed installation notes for Icom mobile transceivers to be fitted into vehicles are available. Please contact your Icom dealer or distributor.

MEMO

<hr/> <hr/> <hr/> <hr/> <hr/> <hr/> <hr/> <hr/> <hr/> <hr/> <hr/> <hr/> <hr/> <hr/> <hr/> <hr/> <hr/> <hr/> <hr/> <hr/> <hr/> <hr/> <hr/> <hr/>	<hr/> <hr/> <hr/> <hr/> <hr/> <hr/> <hr/> <hr/> <hr/> <hr/> <hr/> <hr/> <hr/> <hr/> <hr/> <hr/> <hr/> <hr/> <hr/> <hr/> <hr/> <hr/> <hr/> <hr/>
---	---

Count on us!

< Intended Country of Use >

AT BE CY CZ DK EE
FI FR DE GR HU IE
IT LV LT LU MT NL
PL PT SK SI ES SE
GB IS LI NO CH BG
RO TR HR

A-6732D-1EU-③
Printed in Japan
© 2009–2013 Icom Inc.

Printed on recycled paper with soy ink.

Icom Inc.

1-1-32 Kamiminami, Hirano-ku, Osaka 547-0003, Japan