



## INSTRUCTION MANUAL

# VHF MARINE TRANSCEIVER **IC-M323**



Icom Inc.

---

## FOREWORD

---

Thank you for purchasing this Icom product. The IC-M323 VHF MARINE TRANSCEIVER is designed and built with Icom's state of the art technology and craftsmanship. With proper care, this product should provide you with years of trouble-free operation.

We appreciate you making the IC-M323 your radio of choice, and hope you agree with Icom's philosophy of "technology first." Many hours of research and development went into the design of your IC-M323.

### ◇ **FEATURES**

- *Simple operation with large keys*
- *Easy to hear speaker*
- *Built-in DSC meets ITU Class D requirement*
- *Rugged waterproof construction*
- *Easy to make an individual DSC calls using the optional MA-500TR Class B AIS Transponder*

---

## IMPORTANT

---

**READ ALL INSTRUCTIONS** carefully and completely before using the transceiver.

**SAVE THIS INSTRUCTION MANUAL** — This instruction manual contains important operating instructions for the IC-M323.

---

## EXPLICIT DEFINITIONS

---

WORD	DEFINITION
⚠ <b>WARNING!</b>	Personal injury, fire hazard or electric shock may occur.
<b>CAUTION</b>	Equipment damage may occur.
<b>NOTE</b>	If disregarded, inconvenience only. No risk of personal injury, fire or electric shock.

**CLEAN THE TRANSCEIVER AND MICROPHONE THOROUGHLY WITH FRESH WATER** after exposure to water including salt, otherwise, the keys and switch may become inoperable due to salt crystallization.

---

## IN CASE OF EMERGENCY

---

If your vessel requires assistance, contact other vessels and the Coast Guard by sending a Distress call on Channel 16.

### **USING CHANNEL 16**

#### **DISTRESS CALL PROCEDURE**

1. "MAYDAY MAYDAY MAYDAY."
2. "THIS IS ....." (name of vessel).
3. Say your call sign or other description of the vessel (AND 9 digit DSC ID if you have one).
4. "LOCATED AT ....." (your position).
5. State the nature of the distress and assistance required.
6. Give any other information which might facilitate the rescue.

Or, transmit your Distress call using digital selective calling on Channel 70.

### **USING DIGITAL SELECTIVE CALLING (Ch 70)**

#### **DISTRESS CALL PROCEDURE**

1. While lifting up the key cover, hold down [DISTRESS] for 3 seconds until you hear 3 short beeps and then one long beep.
2. Wait for an acknowledgment on Channel 70 from a coast station.
  - After the acknowledgement is received, Channel 16 is automatically selected.
3. Hold down [PTT], then transmit the appropriate information as listed above.

---

## INSTALLATION NOTE

---

The installation of this equipment should be made in such a manner as to respect the EC recommended electromagnetic field exposure limits (1999/519/EC).

The maximum RF power available from this device is 25 watts. The antenna should be installed as high as possible for maximum efficiency and that this installation height should be at least 5 meters above ground (or accessible) level. In the case where an antenna cannot be installed at a reasonable height, then the transmitter should neither be continuously operated for long periods if any person is within 5 meters of the antenna, nor operated at all if any person is touching the antenna.

In all cases any possible risk depends on the transmitter being activated for long periods. (actual recommendation limits are specified as an average of 6 minutes) Normally the transmitter is not active for long periods of time. Some radio licenses will require that a timer circuit automatically cuts the transmitter after 1–2 minutes etc.

Similarly some types of transmitter, SSB, CW, AM, etc. have a lower 'average' output power and the perceived risk is even lower.

---

## PRECAUTIONS

---

⚠ **WARNING! NEVER** connect the transceiver to an AC outlet. This may pose a fire hazard or result in an electric shock.

⚠ **WARNING! NEVER** connect the transceiver to a power source of more than 16 V DC or use reverse polarity. This will ruin the transceiver.

⚠ **WARNING! NEVER** cut the DC power cable between the DC plug at the back of the transceiver and fuse holder. If an incorrect connection is made after cutting, the transceiver may be damaged.

**CAUTION: NEVER** place the transceiver where normal operation of the vessel may be hindered or where it could cause bodily injury.

**KEEP** the transceiver and microphone at least 1 m away from the vessel's magnetic navigation compass.

**DO NOT** use or place the transceiver in areas with temperatures below  $-20^{\circ}\text{C}$  or above  $+60^{\circ}\text{C}$  or, in areas subject to direct sunlight, such as the dashboard.

**DO NOT** use harsh solvents such as benzine or alcohol to clean the transceiver, as they will damage the transceiver's surfaces. If the transceiver becomes dusty or dirty, wipe it clean with a soft, dry cloth.

**DO NOT** disassemble or modify the transceiver for any reason.

**BE CAREFUL!** The transceiver rear panel will become hot when operating continuously for long periods of time.

Place the transceiver in a secure place to avoid inadvertent use by children.

**BE CAREFUL!** The transceiver meets IPX7 requirements for waterproof protection. However, once the transceiver has been dropped, waterproof protection cannot be guaranteed because of possible damage to the transceiver's case or the waterproof seal.

\* Except for the DC power connector, NMEA In/Out leads and AF Out leads.

Icom, Icom Inc. and the Icom logo are registered trademarks of Icom Incorporated (Japan) in Japan, the United States, the United Kingdom, Germany, France, Spain, Russia and/or other countries.

# COUNTRY CODE LIST

## • ISO 3166-1

	Country	Codes		Country	Codes
1	Austria	AT	18	Liechtenstein	LI
2	Belgium	BE	19	Lithuania	LT
3	Bulgaria	BG	20	Luxembourg	LU
4	Croatia	HR	21	Malta	MT
5	Czech Republic	CZ	22	Netherlands	NL
6	Cyprus	CY	23	Norway	NO
7	Denmark	DK	24	Poland	PL
8	Estonia	EE	25	Portugal	PT
9	Finland	FI	26	Romania	RO
10	France	FR	27	Slovakia	SK
11	Germany	DE	28	Slovenia	SI
12	Greece	GR	29	Spain	ES
13	Hungary	HU	30	Sweden	SE
14	Iceland	IS	31	Switzerland	CH
15	Ireland	IE	32	Turkey	TR
16	Italy	IT	33	United Kingdom	GB
17	Latvia	LV			

# TABLE OF CONTENTS

FOREWORD .....	i
IMPORTANT .....	i
EXPLICIT DEFINITIONS .....	i
IN CASE OF EMERGENCY .....	ii
INSTALLATION NOTE .....	ii
PRECAUTIONS .....	iii
COUNTRY CODE LIST .....	iv
TABLE OF CONTENTS .....	iv
<b>1 OPERATING RULES .....</b>	<b>1</b>
<b>2 PANEL DESCRIPTION .....</b>	<b>2-6</b>
■ Front panel .....	2
■ Function display .....	4
■ Microphone .....	6
■ Softkey function .....	6
<b>3 PREPARATION .....</b>	<b>7-8</b>
■ MMSI code programming .....	7
■ ATIS code programming (For Dutch version transceivers) .....	8
<b>4 BASIC OPERATION .....</b>	<b>9-15</b>
■ Channel selection .....	9
■ Receiving and transmitting .....	11
■ Call channel programming .....	12
■ Channel name programming .....	12
■ Microphone Lock function .....	13

1
2
3
4
5
6
7
8
9
10
11
12
13
14

---

## TABLE OF CONTENTS (Continued)

---

■ Adjusting the volume level.....	14	<b>8 MENU SCREEN OPERATION .....</b>	<b>66–71</b>
■ Adjusting the squelch level.....	14	■ Menu screen operation .....	66
■ Adjusting the display backlight level.....	15	■ Menu screen items.....	67
■ AquaQuake water draining function .....	15	■ Radio Settings items .....	68
<b>5 SCAN OPERATION.....</b>	<b>16–17</b>	■ Configuration items .....	69
■ Scan types .....	16	<b>9 CONNECTIONS AND MAINTENANCE .....</b>	<b>72–76</b>
■ Setting Favorite channels.....	17	■ Connections .....	72
■ Starting a scan.....	17	■ Antenna.....	74
<b>6 DUALWATCH/TRI-WATCH.....</b>	<b>18</b>	■ Fuse replacement .....	74
■ Description .....	18	■ Cleaning.....	74
■ Operation .....	18	■ Supplied accessories.....	74
<b>7 DSC OPERATION .....</b>	<b>19–65</b>	■ Mounting the transceiver.....	75
■ DSC address ID .....	19	■ MB-132 installation .....	76
■ Position and time programming.....	22	<b>10 SPECIFICATIONS AND OPTIONS .....</b>	<b>77–78</b>
■ Distress call.....	23	■ Specifications.....	77
■ Transmitting DSC calls.....	27	■ Options.....	78
■ Receiving DSC calls .....	45	<b>11 CHANNEL LIST.....</b>	<b>79–80</b>
■ Transmitted Call log.....	57	<b>12 TEMPLATE.....</b>	<b>81–82</b>
■ Received Call log.....	58	<b>13 TROUBLE SHOOTING.....</b>	<b>83</b>
■ DSC Settings .....	60		
■ Making an Individual call using an AIS transponder ..	64		

## ◇ Priorities

- Read all rules and regulations pertaining to call priorities, and keep an up-to-date copy handy. Safety and distress calls take priority over all others.
- You must monitor Channel 16 when you are not operating on another channel.
- False or fraudulent distress calls are prohibited under law.

## ◇ Privacy

- Information overheard, but not intended for you, cannot lawfully be used in any way.
- Indecent or profane language is prohibited.

## ◇ Radio licenses

### (1) SHIP STATION LICENSE

You may require a current radio station license before using the transceiver. It is unlawful to operate a ship station which is not licensed, but required to be.

If required, contact your dealer or the appropriate government agency for a Ship-Radiotelephone license application. This government-issued license states the call sign which is your craft's identification for radio purposes.

### (2) OPERATOR'S LICENSE

A Restricted Radiotelephone Operator Permit is the license most often held by small vessel radio operators when a radio is not required for safety purposes.

If required, the Restricted Radiotelephone Operator Permit must be posted or kept with the operator. If required, only a licensed radio operator may operate a transceiver.

However, non-licensed individuals may talk over a transceiver if a licensed operator starts, supervises, ends the call and makes the necessary log entries.

A current copy of the applicable government rules and regulations is only required to be on hand for vessels in which a radio telephone is compulsory. However, even if you are not required to have these on hand it is your responsibility to be thoroughly acquainted with all pertinent rules and regulations.

## ■ Front panel

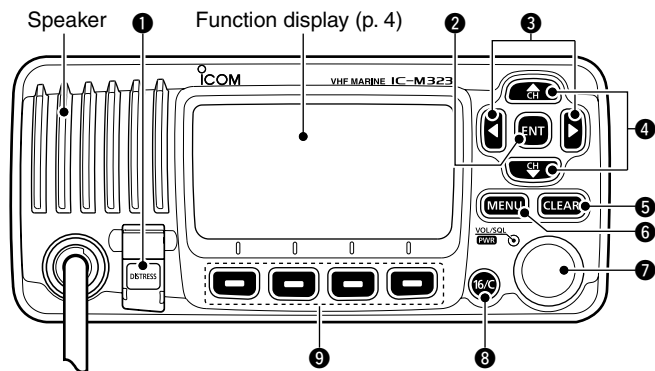

### 1 DISTRESS KEY [DISTRESS] (pp. 23, 24)

Hold down for 3 seconds to transmit a Distress call.

### 2 ENTER KEY [ENT] (pp. 7, 10, 66)

Push to set the input data, selected item, and so on.

### 3 LEFT AND RIGHT KEYS [◀]/[▶]

- ➔ Push to switch to the previous or next key function that is assigned to the softkeys. (p. 6)
- ➔ Push to select the desired character or number in the table while in the channel name, position, MMSI code programming mode, and so on. (pp. 7, 12, 22)

### 4 UP AND DOWN/CHANNEL SELECT KEYS [▲•CH]/[▼•CH]

- ➔ Push to select the operating channels, Menu items, Menu settings, and so on. (pp. 11, 66)
- ➔ Push to check Favorite channels, change the scanning direction or manually resume a scan. (p. 17)

### 5 CLEAR KEY [CLEAR] (pp. 7, 12, 66)

Push to cancel the entered data, or to return to the previous screen.

### 6 MENU KEY [MENU] (p. 66)

Push to enter or exit the Menu screen.

### 7 VOLUME AND SQUELCH SWITCH/POWER SWITCH [VOL/SQL•PWR]

- ➔ When the power is OFF, hold down for 1 second to turn ON power. (p. 11)
- ➔ Hold down for 1 second to turn OFF power.
- ➔ When the power is ON, push to enter the volume level adjustment mode.\* (p. 14)
  - Each push of this switch toggles the mode between the volume level adjustment, squelch threshold level adjustment, operating channel selection and the LCD and key backlight brightness adjustment, if assigned.
- ➔ Rotate to adjust the volume level.\* (p. 14)

\*The desired function can be assigned in the Menu screen.



**8 CHANNEL 16/CALL CHANNEL KEY [16/C]**

- ➔ Push to select Channel 16. (p. 9)
- ➔ Hold down for 1 second to select the Call channel. (p. 9)
  - “CALL” appears when the Call channel is selected.
- ➔ Hold down for 3 seconds to enter Call channel programming mode when the Call channel is selected. (p. 12)

**9 SOFTKEYS**

The desired functions as described below can be assigned in the Menu screen.

**Scan [SCAN]** (p. 17)

Push to start or stop a Normal or Priority scan.

**Dualwatch/Tri-watch [DW]** (p. 18)

- ➔ Push to start a Dualwatch or Tri-watch.
- ➔ Push to stop a Dualwatch or Tri-watch when either is activated.

**High/Low [HI/LO]** (p. 11)

Push to set the power to high or low.  
 • Some channels are set to only low power.

**Channel [CHAN]** (p. 9)

Push to select a regular channel.

**AquaQuake [AQUA]** (p. 15)

While holding down, the AquaQuake function is activated to clear water away from the speaker grill.

**Favorite channel [★]** (p. 17)

- ➔ Push to set or clear the displayed channel as a Favorite (Tag) channel.
- ➔ Hold down for 3 seconds to clear or set all Favorite channels in the selected channel group.

**Name [NAME]** (p. 12)

Push to enter the channel name programming mode.

**Backlight [BKLT]** (p. 15)

Push to enter the LCD and key backlight brightness adjustment mode.

- While in the adjustment mode, push [▲]/[▼]/[◀]/[▶] or rotate Dial to adjust the brightness of the LCD and key backlight.

**Log [LOG]** (p. 58)

Push to enter “RCVD CALL LOG” in the DSC CALLS menu.

## 2 PANEL DESCRIPTION

### ■ Function display

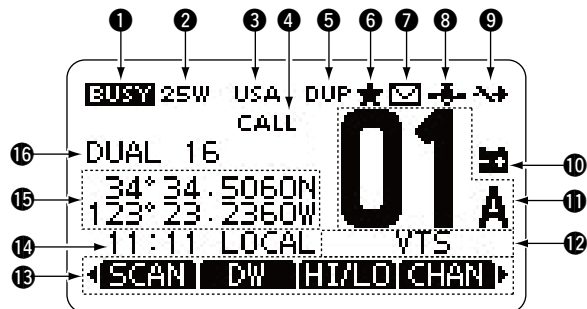

- ❶ **BUSY/TRANSMIT ICON** (p. 11)
  - ➔ “BUSY” appears when receiving a signal or when the squelch is open.
  - ➔ “TX” appears while transmitting.
- ❷ **POWER ICON** (p. 11)
  - ➔ “25W” appears when high power is selected.
  - ➔ “1W” appears when low power is selected.
- ❸ **CHANNEL GROUP ICON** (p. 10)

Shows which channel group is selected, a U.S.A. “USA,” International “INT,” ATIS “ATIS” or DSC “DSC”, depending on the version.

- ❹ **CALL CHANNEL ICON** (p. 9)

Appears when the Call channel is selected.
- ❺ **DUPLEX ICON** (p. 10)

Appears when a duplex channel is selected.
- ❻ **FAVORITE CHANNEL ICON** (p. 17)

Appears when a Favorite (Tag) channel is selected.
- ❼ **MESSAGE ICON** (p. 58)

Blinks when there is an unread DSC message.
- ❽ **GPS ICON**
  - ➔ Stays ON when the connected GPS receiver is activated and valid position data is received.
  - ➔ Blinks when invalid position data is being received.
- ❾ **SWITCH ICON** (p. 61)

Appears when the “CH 16 SWITCH” in DSC Settings is set to ‘OFF.’
- ❿ **LOW BATTERY ICON**

Blinks when the battery voltage drops to approximately 10 V DC or less.
- ⓫ **CHANNEL NUMBER READOUT**

Shows the selected operating channel number.

  - When a simplex channel is selected, “A” appears.
- ⓬ **CHANNEL NAME FIELD**

The channel name appears, if programmed. (p. 12)

**13 KEY ICON** (p. 6)

Shows the programmed function of the softkeys on the front panel.

**14 TIME ZONE INDICATOR**

- Shows the current time when a GPS receiver is connected, or the time is manually programmed.
  - When the GPS current time is invalid, “??” will blink every 2 seconds instead of current time. After 23.5 hours has passed, “NO TIME” will appear.
  - “??” will blink every 2 seconds instead of the current time, after 4 hours have passed from the time when the time was manually programmed. The manually programmed time is held for only 23.5 hours, and after that, “NO TIME” will appear.
- “LOCAL” appears when the offset time is set.
- “MNL” appears when the time is manually programmed.
- “UTC” appears when the GGA, GLL and GNS GPS sentence format is included in the GPS signal.
- The date information appears when the RMC GPS sentence format is included in the GPS signal.
- “NO TIME” appears when no GPS receiver is connected, and no time is manually input.

**15 POSITION INDICATOR**

- Shows the current position when a GPS receiver is connected, or the position is manually programmed.
  - When the GPS position is invalid, “??” may blink every 2 seconds instead of position. The last position is held for only 23.5 hours, and after that, “NO POSITION” will appear.
  - “??” will blink every 2 seconds instead of position, after 4 hours have passed from the time when the position is manually programmed. The manually programmed position is held for only 23.5 hours, and after that, “NO POSITION” will appear.
- “NO POSITION” appears when no GPS receiver is connected, and no position is manually input.

**16 SCAN INDICATOR**

- “SCAN 16” appears during a Priority scan; “SCAN” appears during a Normal scan. (p. 17)
- “DUAL 16” appears during Dualwatch; “TRI 16” appears during Tri-watch. (p. 18)

## 2 PANEL DESCRIPTION

### ■ Microphone

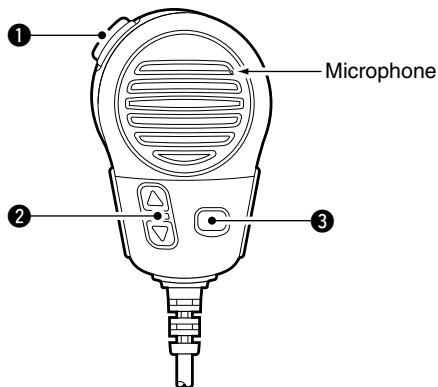

#### ① PTT SWITCH [PTT]

Hold down to transmit, release to receive. (p. 11)

#### ② CHANNEL UP/DOWN KEYS [▲]/[▼]

- Push either key to check Favorite channels. (p. 11)
- Push either key to change scanning direction or manually resumes a scan. (p. 17)

#### ③ TRANSMIT POWER KEY [HI/LO]

- Push to toggle the power high or low. (p. 11)
  - Some channels are set to only low power.
- While holding down [HI/LO], turn ON the power to turn the Microphone Lock function ON or OFF. (p. 13)

### ■ Softkey function

Various functions can be assigned to the softkeys.

When the key function is assigned, the key icon is displayed above the softkey, as shown below.

#### ◇ Softkey function selection

- When “◀” or “▶” is displayed beside the key icon, pushing [◀] or [▶] sequentially shows the previous or next key function that is assigned to the softkey.

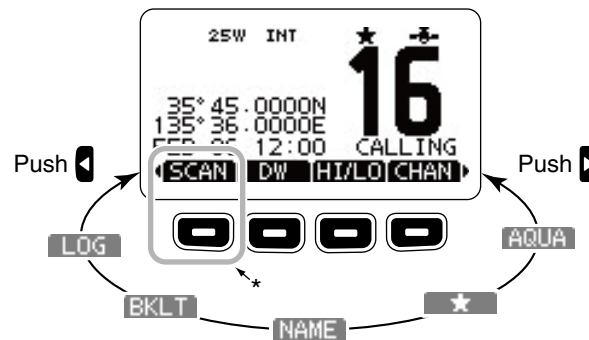

\*Push this key to start or stop scan.

/// The order of the key icons may differ, depending on the preprogramming.

## ■ MMSI code programming

The 9 digit MMSI (Maritime Mobile Service Identity: DSC self ID) code can be programmed at power ON.

**This initial code setting can be performed only once. After being set, it can be changed by only your dealer or distributor. If your MMSI code has already been programmed, this programming is not necessary.**

- ① Hold down [PWR](Dial) to turn ON the power.
  - Three short beeps sound, and “NO DSC MMSI” is displayed.
- ② Push [ENT] to start the MMSI code programming.
  - Push [CLEAR] twice to cancel the programming, and go to the normal operating screen. In this case, the transceiver cannot make a DSC call. To program the MMSI code, turn OFF the power, then turn it ON again.
- ③ Enter your MMSI code in the following manner:
  - Select a desired number using Dial, or [▲]/[▼]/[◀]/[▶].
  - Push [ENT] or Dial to set it.
  - To move the cursor, select either arrow, “←” or “→,” then push [ENT] or Dial.

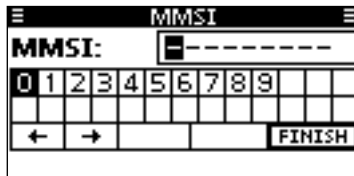

- ④ Repeat step ③ to enter all 9 digits.
- ⑤ After entering the 9 digit code, “FINISH” is automatically selected, and then push [ENT] or Dial to set it.
- ⑥ The “MMSI CONFIRMATION” screen is displayed.

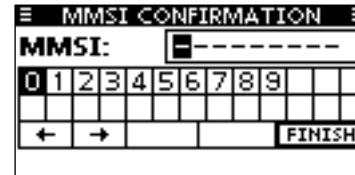

- ⑦ Enter your MMSI code again for confirmation.
  - Enter in the same manner as steps ③ through ⑤.
- ⑧ When your MMSI code programming is successfully completed, the screen as shown below is briefly displayed.
  - After that, the normal operating screen is displayed.



The programmed MMSI code can be checked in the MENU screen. (p. 67)

**NOTE:** Depending on the transceiver version, the ATIS code programming may be required after programming the MMSI code. See the next page for details.

### 3 PREPARATION

## ■ ATIS code programming (For Dutch version transceivers)

The 10 digit ATIS (Automatic Transmitter Identification System) code can be programmed at power ON.

**This initial code setting can be performed only once. After being set, it can be changed by only your dealer or distributor. If your ATIS code has already been programmed, this programming is not necessary.**

- ① After programming the MMSI code, "Push [ENT] to Register Your ATIS" is displayed.
- ② Push [ENT] to start the ATIS code programming.
  - Push [CLEAR] twice to cancel the programming, and go to the normal operating mode. In this case, the ATIS function is disabled. To program the ATIS code, turn OFF the power, then turn it ON again.
- ③ Enter your ATIS code in the following manner:
  - Select a desired number using Dial, or [▲]/[▼]/[◀]/[▶].
  - Push [ENT] or Dial to set it.
  - To move the cursor, select either arrow, "←" or "→," then push [ENT] or Dial.

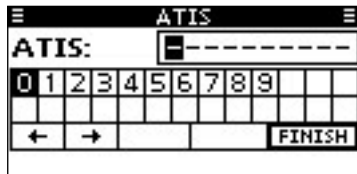

- ④ Repeat step ③ to enter all 10 digits.
- ⑤ After entering the 10 digit code, "FINISH" is automatically selected, and then push [ENT] or Dial to set it.
- ⑥ The "ATIS CONFIRMATION" screen is displayed.

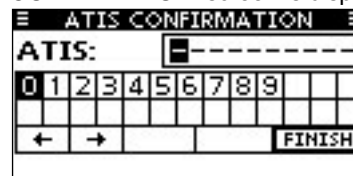

- ⑦ Enter your ATIS code again for confirmation.
  - Enter in the same manner as steps ③ through ⑤.
- ⑧ When your ATIS code programming is successfully completed, the screen as shown below is briefly displayed.
  - After that, the normal operating screen is displayed.



The programmed ATIS code can be checked in the MENU screen. (p. 67)

## ■ Channel selection

### ◇ Channel 16

Channel 16 is the distress and safety channel. It is used for establishing initial contact with a station and for emergency communications. Channel 16 is monitored during both Du-alwatch and Tri-watch. While standing by, you must monitor Channel 16.

- ➔ Push [16/C] to select Channel 16.
- ➔ Push [CHAN] to return to the screen displayed before you selected Channel 16, or push [▲](CH) or [▼](CH) to select an operating channel.



### ◇ Call channel

Each regular channel group has a separate leisure use Call channel. The Call channel is monitored during Tri-watch. The Call channels can be programmed, and are used to store your most often used channel in each channel group, for quick recall. (p. 12)

- ➔ Hold down [16/C] for 1 second to select the Call channel of the selected channel group.
  - "CALL" and the Call channel number appear.
  - Each channel group has an independent call channel after programming. (p. 12)
- ➔ Push [CHAN] to return to the screen displayed before you selected Call channel, or push [▲](CH) or [▼](CH) to select an operating channel.



## 4 BASIC OPERATION

### ◇ Channel group selection

There are preprogrammed international channels for the IC-M323. For U.K. version transceivers, there are preprogrammed U.S.A. channels in addition to International channels. In addition to the International channels, there are preprogrammed ATIS channels for the Dutch, and DSC channels for the German version transceivers.

Except for the Europe version, you can select a channel group suitable for your operating area, as described below.

- ① Push [MENU].
- ② Rotate Dial or push [▲]/[▼] to select “Radio Settings,” and then push [ENT].
- ③ Rotate Dial or push [▲]/[▼] to select “CHAN Group,” and then push [ENT].



- ④ Rotate Dial or push [▲]/[▼] to select the desired channel group, and then push [ENT].
  - U.S.A., (USA) International (INT), ATIS or DSC\* channel groups may be selected, depending on the version.



- ⑤ Push [EXIT] to exit the Menu screen.
- ⑥ Push [▲](CH) or [▼](CH) to select a channel.
  - Pushing [▲]/[▼] on the microphone selects only Favorite channels.
  - “DUP” appears when a duplex channel is selected.
  - “A” appears when a simplex channel is selected.

Channel group icon appears

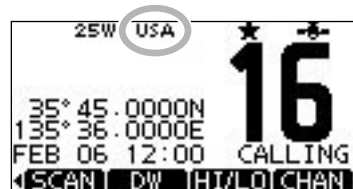

When the U.S.A. channel group is selected.



## ■ Receiving and transmitting

**CAUTION:** Transmitting without an antenna will damage the transceiver.

- ① Hold down [PWR](Dial) to turn ON the power.
- ② Set the audio and squelch levels. (p. 14)
  - ➔ First, open the squelch. Then, adjust the audio output level. After that, adjust the squelch level until the noise just disappears.
- ③ Change the channel group. (p. 10)
- ④ Push [▲](CH) or [▼](CH) to select a channel. (pp. 9, 10)
  - Pushing [▲]/[▼] on the microphone also selects a channel.
  - When receiving a signal, “**BUSY**” appears and audio is heard.
  - Further adjustment of the volume level may be necessary.
- ⑤ Push [HI/LO] to select the output power, if necessary.
  - Pushing [HI/LO] on the microphone also selects the output power.
  - “25W” appears when high power is selected, and “1W” appears when low power is selected.
  - Choose low power for short range communications, choose high power for longer distance communications.
  - Some channels are for only low power.
- ⑥ Hold down [PTT] to transmit, then speak at your normal voice level.
  - “**TX**” appears.
  - Channel 70 cannot be used for transmission other than DSC.
- ⑦ Release [PTT] to receive.

**IMPORTANT:** To maximize the readability of your transmitted signal, pause a few seconds after pushing [PTT], hold the microphone 5 to 10 cm from your mouth and speak at a normal voice level.

### ✓ NOTE for the TOT (Time-out Timer) function

The TOT function inhibits continuous transmission beyond a preset time period after the transmission starts.

10 seconds before transmission is cutoff, a beep sounds to indicate the transmission will be shut down and “TOT” appears in the channel name field. Transmission is not possible for 10 seconds after this shut down.

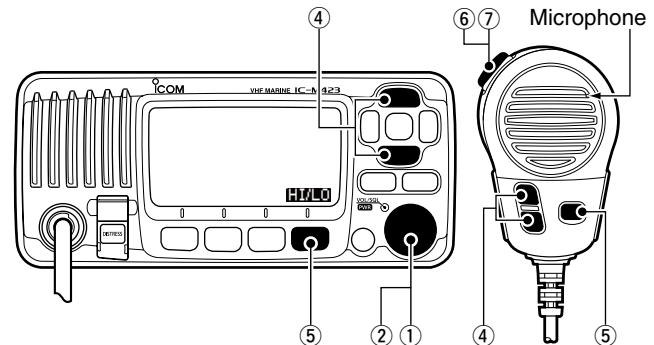

## 4 BASIC OPERATION

### ■ Call channel programming

You can program the Call channel with your most often-used channel in each channel group for quick recall.

- ① Select the desired channel group (INT, USA, ATIS or DSC) to be programmed. (p. 10)
- ② Hold down [16/C] for 1 second to select the Call channel of the selected channel group.
  - “CALL” and the Call channel number appear.
- ③ Hold down [16/C] again for 3 seconds (until a long beep changes to 2 short beeps) to enter the Call channel programming mode.
- ④ Rotate Dial or push [▲](CH)/[▼](CH) to select a channel.

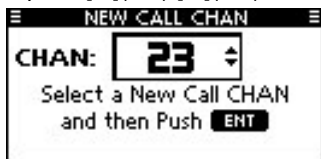

- ⑤ Push [ENT] to program the displayed channel as the Call channel.
  - Push [CLEAR] to cancel.



### ■ Channel name programming

Each channel can be assigned a unique alphanumeric ID of up to 10 characters.

Capital letters, 0 to 9, some symbols (! " # \$ % & ' ( ) \* + , - . / [ \ ] ^ \_ ; < = > ?) and a space can be input.

- ① Push [▲](CH) or [▼](CH) to select a channel.
  - First, cancel the Dualwatch, Tri-watch or Scan function, if activated.
- ② Push [NAME] to open the channel name programming screen.
  - A black box is displayed on the first character.
- ③ Enter the desired channel name in the following manner:
  - Select a desired character using Dial, or [▲]/[▼]/[◀]/[▶].
  - Push [ENT] or Dial to set it.
  - To move the cursor, select either arrow, “←” or “→,” then push [ENT] or Dial.
  - Select “SPACE,” then push [ENT] to input a space.
  - Select “DELETE,” then push [ENT] to delete a character.
  - Push [CLEAR] to cancel and return to the previous screen.



- ④ Repeat step ③ to input all characters.



- ⑤ Push [◀], [▶], [▲] or [▼] to select "FINISH," then push [ENT] to set the name and return to the previous screen.

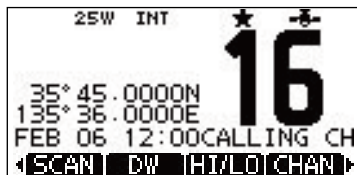

## Microphone Lock function

The Microphone Lock function electrically locks [▲], [▼] and the [HI/LO] keys on the supplied microphone. This prevents accidental channel changes and function access.

- ➔ While holding down [HI/LO] on the microphone, hold down [PWR](Dial) to turn ON the transceiver and turn the Microphone Lock function ON or OFF.

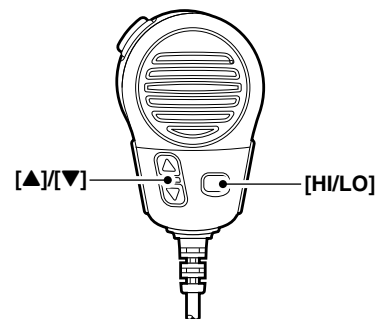

## 4 BASIC OPERATION

### ■ Adjusting the volume level

The volume level can be adjusted with [VOL/SQL](Dial).

- ① Rotate [VOL/SQL](Dial), or push [VOL/SQL](Dial) one or more times to display the volume adjustment screen.
- ② Rotate [VOL/SQL](Dial) to adjust the volume level.
  - The transceiver has 20 volume levels and OFF.
  - If no key operation is performed for about 5 seconds, the transceiver sets the selected volume level, and returns to the normal mode.
- ③ Push [ENT] to set the level, and exit the volume adjustment mode.
  - Push [CLEAR] to cancel.

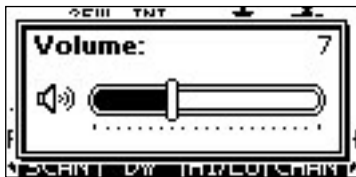

/// The desired function can be assigned to Dial. See page 70 for details.

### ■ Adjusting the squelch level

The squelch level can be adjusted with [VOL/SQL](Dial).

In order to receive signals properly, as well as for the scan to function effectively, the squelch must be adjusted to the proper level.

- ① Push [VOL/SQL](Dial) one or more times to display the squelch adjustment screen.
- ② Rotate [VOL/SQL](Dial) to adjust the squelch level.
  - The transceiver has 11 squelch levels: OPEN is completely open; 10 is tight squelch; 1 is loose squelch.
  - If no key operation is performed for about 5 seconds, the transceiver sets the selected squelch level, and returns to the normal mode.
- ③ Push [ENT] to set the level, and exit the squelch adjustment mode.
  - Push [CLEAR] to cancel.

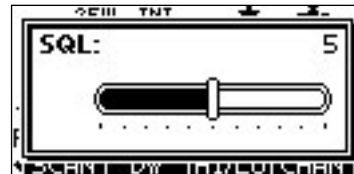

/// The desired function can be assigned to Dial. See page 70 for details.

## ■ Adjusting the display backlight level

The function display and keys can be backlit for better visibility under low light conditions.

The backlight is adjustable in 7 levels and OFF.

Depending on the preprogramming, the adjustment method differs, as described below.

- Push [BKLT] to show the backlight adjustment screen. Rotate Dial to adjust the brightness of the LCD and key backlight, and then, push [ENT].
  - If no key operation is performed for about 5 seconds, the transceiver sets the selected backlight level, and returns to the normal mode.

**When the Backlight function is assigned to the [VOL/SQL](Dial):**

- ① Push [VOL/SQL](Dial) one or more times to display the backlight adjustment screen.
- ② Rotate [VOL/SQL](Dial) to adjust the brightness of the LCD and key backlight, and then, push [ENT].



/// The desired function can be assigned to Dial. See page 70 for details.

## ■ AquaQuake water draining function

The AquaQuake water draining function clears water away from the speaker grill. Without this function, water may muffle the sound coming from the speaker. A buzzing sound is heard when this function is activated.

- While holding down [AQUA], the AquaQuake function is activated to clear water away from the speaker grill.
  - While holding down [AQUA], a low buzzing sounds to drain water, regardless of the volume level setting.
  - The transceiver keys, except [DISTRESS], are disabled while the AquaQuake function is activated.



When the AquaQuake function is activated.

## ■ Scan types

Scanning is an efficient way to locate signals quickly over a wide frequency range. The transceiver has a Priority scan and a Normal scan.

### PRIORITY SCAN

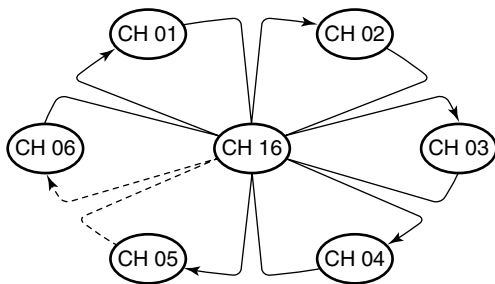

The Priority scan sequentially searches through all Favorite channels while monitoring Channel 16. When a signal is detected on Channel 16, the scan pauses until the signal disappears. When a signal is detected on a channel other than Channel 16, the scan becomes a Dualwatch until the signal disappears.

Set the Favorite channels (scanned channel) before scanning. Clear the Favorite channels which inconveniently stop scanning, such as those for digital communication use. (Refer to the next page for details.)

/// Choose Priority or Normal scan in the Menu screen. (p. 68)

### NORMAL SCAN

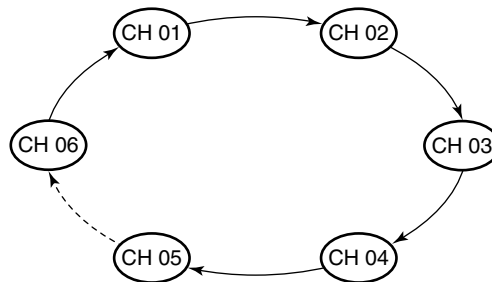

The Normal scan, like the Priority scan, sequentially searches through all Favorite channels. However, unlike the Priority scan, Channel 16 is not checked unless it is set as a Favorite channel.

## ■ Setting Favorite channels

For more efficient scanning, add desired channels as Favorite channels, or clear the Favorite on unwanted channels. Channels that are not tagged will be skipped while scanning. Favorite channels can be independently assigned to each channel group (INT, USA, ATIS or DSC).

- ① Select the desired channel group. (p. 10)
- ② Select the desired channel to be set as a Favorite channel.
- ③ Push [★] to set the displayed channel as a Favorite channel.
  - “★” appears on the display.
- ④ To cancel the Favorite channel setting, repeat step ③.
  - “★” disappears.

### ✓ Clearing (or setting) all Favorite channels

Hold down [★] for 3 seconds (until a long beep changes to 2 short beeps) to clear all Favorite channel settings in the selected channel group.

- Repeat above procedure to set all channels as Favorite channels.

## ■ Starting a scan

First, set the scan type (Priority or Normal scan) and scan resume timer in the Menu screen. (p. 68)

- ① Select the desired channel group. (p. 10)
- ② Set the Favorite channels, as described to the left.
- ③ Make sure the squelch is closed to start a scan.
- ④ Push [SCAN] to start a Priority or Normal scan.
  - “SCAN 16” appears during a Priority scan; “SCAN” appears during a Normal scan.
  - When a signal is detected, the scan pauses until the signal disappears, or resumes after pausing 5 seconds, depending on the setting. (Channel 16 is still monitored during a Priority scan.)
  - Push [▲]/[▼] on either transceiver or microphone, to check the scanning Favorite channels, change the scanning direction or manually resume the scan.
  - A beep tone sounds and “16” blinks when a signal is received on Channel 16 during a Priority scan.
- ⑤ To stop the scan, push [CLEAR] or repeat step ④.

**[Example]:** Starting a Normal scan.

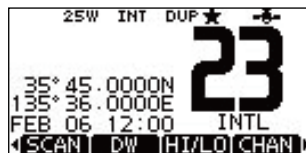

Push  
[SCAN]

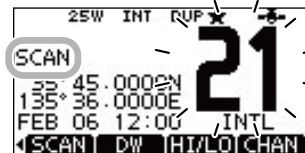

Scan starts.

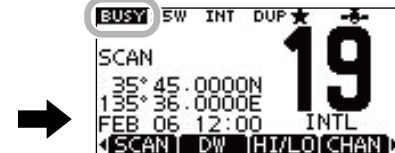

When a signal is received.

## ■ Description

Dualwatch monitors Channel 16 while you are receiving on another channel; Tri-watch monitors Channel 16 and the Call channel while receiving another channel. Dualwatch and Tri-watch are convenient for monitoring Channel 16 when you are operating on another channel.

### DUALWATCH/TRI-WATCH SIMULATION

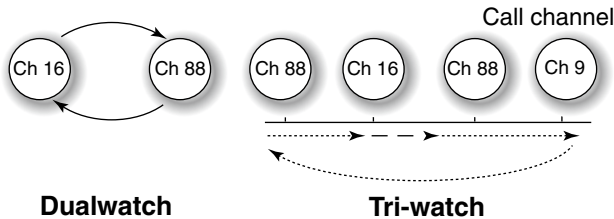

- If a signal is received on Channel 16, Dualwatch and Tri-watch pause on Channel 16 until the signal disappears.
- If a signal is received on the Call channel during Tri-watch, Tri-watch becomes Dualwatch until the signal disappears.
- To transmit on the selected channel during a Dualwatch or Tri-watch scan, hold down [PTT].

## ■ Operation

- ① Select Dualwatch or Tri-watch in the Menu screen. (p. 68)
- ② Push [▲](CH) or [▼](CH) to select the desired operating channel.
- ③ Push [DW] to start a Dualwatch or Tri-watch scan.
  - “DUAL 16” appears during Dualwatch; “TRI 16” appears during Tri-watch.
  - A beep tone sounds when a signal is received on Channel 16.
- ④ To cancel Dualwatch or Tri-watch, push [DW] again.

**[Example]:** Operating Tri-watch on INT Channel 25.

Tri-watch starts.

```

25W INT DUF ★
TRI 16
35° 45.0000N 25
135° 36.0000E
FEB 06 12:00 TELEPHONE
[SCAN] [DW] [HI/LO] [CHAN]
  
```

Signal is received on Call channel.

```

BUSY 25W INT DUF ★
CALL
TRI 16
35° 45.0000N 16
135° 36.0000E
FEB 06 12:00 CALLING
[SCAN] [DW] [HI/LO] [CHAN]
  
```

Tri-watch resumes after the signal disappears.

```

25W INT DUF ★
TRI 16
35° 45.0000N 25
135° 36.0000E
FEB 06 12:00 TELEPHONE
[SCAN] [DW] [HI/LO] [CHAN]
  
```

Signal received on Channel 16 takes priority.

```

BUSY 25W INT DUF ★
TRI 16
35° 45.0000N 25
135° 36.0000E
FEB 06 12:00 TELEPHONE
[SCAN] [DW] [HI/LO] [CHAN]
  
```



## ■ DSC address ID

### ◇ Programming Individual ID

A total of 100 DSC address IDs can be programmed and assigned a name of up to 10 characters.

- ① Enter “INDIVIDUAL ID” in the DSC SETTINGS menu.

◀MENU▶ ⇄ ▶DSC Settings▶ ⇄ ▶Individual ID▶  
 (Push [MENU]) (Rotate Dial, then push [ENT].)

- ② Push [ADD].

• The “INDIVIDUAL ID” program screen is displayed.

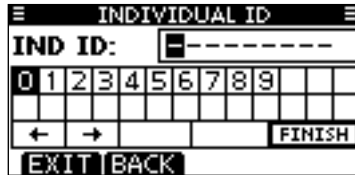

- ③ Enter a desired individual ID in the following way:

- Select a desired number using Dial, or [▲]/[▼]/[◀]/[▶].
- Push [ENT] or Dial to set it.
- To move the cursor, select either arrow, “←” or “→,” then push [ENT] or Dial.

- ▨ The first digit is specified as ‘0’ for a Group ID.
- ▨ The first two digits are ‘0’ for any Coast station ID.

- ④ Repeat step ③ to enter all 9 digits.

- ⑤ After entering the 9 digit code, push [ENT] or Dial to set it.  
 • ID name programming screen is displayed.



- ⑥ Enter a desired 10 digit ID name in the following way:

- Select a desired character using Dial, or [▲]/[▼]/[◀]/[▶].
- Push [ENT] or Dial to set it.
- To move the cursor, select either arrow, “←” or “→,” then push [ENT] or Dial.
- Push [123] then [!\$?] then [ABC] to select a character group.

- ⑦ After entering the ID name, select “FINISH” using Dial, or [▲]/[▼]/[◀]/[▶], then push [ENT] or Dial to program it.

- The “INDIVIDUAL ID” list screen is displayed.



- ⑧ Push [MENU] to exit the MENU screen.

## 7 DSC OPERATION

### ◇ Programming Group ID

- ① Enter "GROUP ID" in the DSC SETTINGS menu.

◀MENU	⇄	◀DSC Settings	⇄	◀Group ID
(Push [MENU])		(Rotate Dial, then push [ENT].)		

- ② Push [ADD].

- The "GROUP ID" program screen is displayed.



- ③ Enter a desired group ID in the following way:
- Select a desired number using Dial, or [▲]/[▼]/[◀]/[▶].
  - Push [ENT] or Dial to set it.
  - To move the cursor, select either arrow, "←" or "→," then push [ENT] or Dial.
- /// The first digit is fixed as '0' for a Group ID.  
/// The first two digits are '0' for any Coast station ID.

- ④ Repeat step ③ to input the specific 9 digits group code.

- ⑤ After entering the 9 digit code, push [ENT] or Dial to set it.
- Group ID name programming screen is displayed.



- ⑥ Enter a desired 10 digit ID name in the following way:
- Select a desired character using Dial, or [▲]/[▼]/[◀]/[▶].
  - Push [ENT] or Dial to set it.
  - To move the cursor, select either arrow, "←" or "→," then push [ENT] or Dial.
  - Push [123], [!\$?] or [ABC] to select a character group.
- ⑦ After entering the ID name, select "FINISH" using Dial, or [▲]/[▼]/[◀]/[▶], then push [ENT] or Dial to program it.
- The "GROUP ID" list screen is displayed.



- ⑧ Push [MENU] to exit the MENU screen.

### ◇ Deleting Individual/Group ID

- ① Enter "INDIVIDUAL ID" or "GROUP ID" in the DSC SETTINGS menu.

◀MENU▶ ⇄ ▶DSC Settings▶ ⇄ ▶Individual ID▶/▶Group ID▶  
(Push [MENU]) (Rotate Dial, then push [ENT].)

• When no address ID is programmed, "No ID" is displayed. In this case, push [MENU] to exit the MENU screen.

- ② Rotate Dial or push [▲]/[▼] to select a desired ID name, then push [DEL].

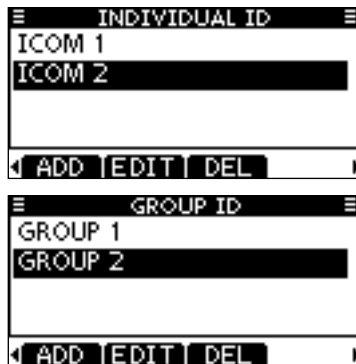

- ③ Push [OK] to delete the ID, and return to the "INDIVIDUAL ID" or "GROUP ID" list screen.
- Push [CANCEL] to cancel it.



- ④ Push [MENU] to exit the MENU screen.

## ■ Position and time programming

A Distress call should include the ship's position and time. If no GPS is connected, your position and UTC (Universal Time Coordinated) time should be manually input. They are automatically included when a GPS receiver compatible with the NMEA0183 ver. 2.0 or 3.01 format is connected.

- ▨ Manual programming is disabled when a GPS receiver is connected.
- ▨ Manually programmed position and time will be held for only 23.5 hours.

① Enter "POSITION INPUT" in the DSC SETTINGS menu.

◀MENU▶ ⇄ ▶DSC Settings▶ ⇄ ▶Position Input▶  
 (Push [MENU]) (Rotate Dial, then push [ENT].)

② Edit your latitude and longitude position using Dial, or [▲]/[▼]/[◀]/[▶].

- Select a desired number using Dial, or [▲]/[▼]/[◀]/[▶].
- Push [ENT] or Dial to set it.
- To move the cursor, select either arrow, "←" or "→," then push [ENT] or Dial.
- Select N (North latitude) or S (South latitude) when the cursor is on the 'N' or 'S' position.
- Select W (West longitude) or E (East longitude) when the cursor is on the 'W' or 'E' position.

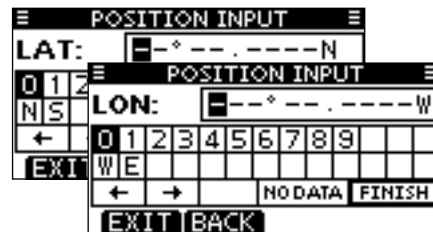

- ③ After entering the position, push [ENT] to program it.
- ④ The UTC time programming screen is displayed, enter the UTC time in the following way:
  - Select a desired number using Dial, or [▲]/[▼]/[◀]/[▶].
  - Push [ENT] or Dial to set it.
  - To move the cursor, select either arrow, "←" or "→," then push [ENT] or Dial.

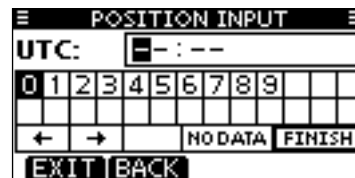

- ⑤ Push [ENT] or Dial to program your position and time.
  - Return to the "DSC SETTINGS" screen.

## ■ Distress call

A Distress call should be transmitted if, in the opinion of the Master, the ship or a person is in distress and requires immediate assistance.

**NEVER MAKE A DISTRESS CALL IF YOUR SHIP OR A PERSON IS NOT IN AN EMERGENCY. A DISTRESS CALL SHOULD BE MADE ONLY WHEN IMMEDIATE HELP IS NEEDED.**

### ◇ Simple call

- ① Confirm no Distress call is being received.
- ② While lifting up the key cover, hold down [DISTRESS] for 3 seconds to transmit the Distress call.
  - While holding down [DISTRESS], count down beeps sound and both the key and display backlighting blink.
  - DSC channel (Channel 70) is automatically selected and the Distress call is transmitted.

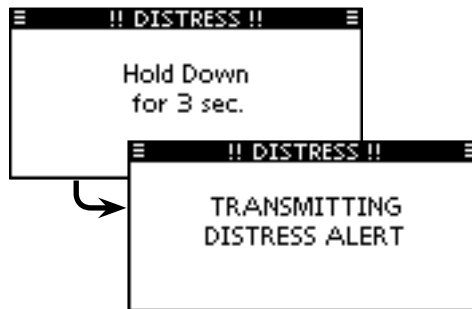

- ③ After transmitting the call, the transceiver waits for an acknowledgment call.
  - The Distress call is automatically transmitted every 3.5 to 4.5 minutes, until an acknowledgement is received ('Call repeat' mode), or DSC Cancel call is made (p. 26).
  - Push [RESEND] to manually transmit the Distress repeat call.
  - Push [◀]/[▶] then push [INFO] to display the transmitted Distress call information.
  - Push [◀]/[▶] then push [PAUSE] to pause the 'Call repeat' mode, push [RESUME] to resume it.



- ④ After receiving the acknowledgment, push [ALARM OFF] then reply using the microphone.
  - ➔ A distress alert default contains:
    - Nature of distress : Undesignated distress
    - Position information : The latest GPS or manual input position is held for 23.5 hours, or until the power is turned OFF.

## 7 DSC OPERATION

### ◇ Regular call

The nature of the Distress call should be included in the Distress call.

- ① Enter "DISTRESS CALL" in the DSC CALLS menu.

◀MENU▶ ⇔ ◀DSC Calls▶ ⇔ ◀Distress Call▶  
(Push [MENU]) (Rotate Dial, then push [ENT].)

- ② Select the nature of the distress using Dial or [▲]/[▼], then push Dial or [ENT].

- 'Undesignated,' 'Fire,Explosion,' 'Flooding,' 'Collision,' 'Grounding,' 'Capsizing,' 'Sinking,' 'Adrift,' 'Abandoning ship,' 'Piracy' or 'Man Overboard' is selectable.
- The nature of the distress is stored for 10 minutes after a selection is made.

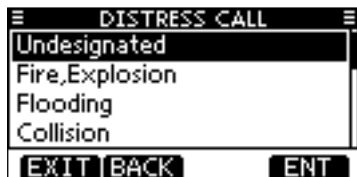

- ③ The Distress call confirmation screen is displayed.
- Rotate Dial or push [▲]/[▼] to see the hidden lines.

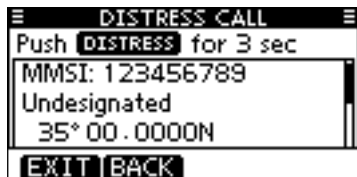

- ④ Hold down [DISTRESS] for 3 seconds to transmit the Distress call.

- While holding down [DISTRESS], count down beeps sound and both the key and display backlighting blink.
- The selected nature of the distress is stored for 10 minutes.

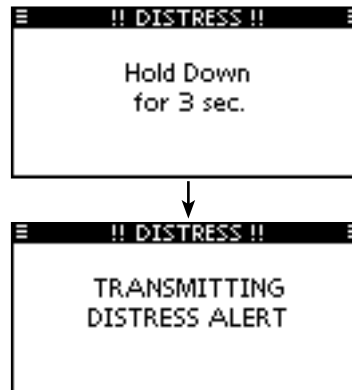

- ⑤ After transmitting the call, the transceiver waits for an acknowledgment call.
- The Distress call is automatically transmitted every 3.5 to 4.5 minutes, until an acknowledgement is received ('Call repeat' mode), or DSC cancel call is made (p. 26).
  - Push [RESEND] to manually transmit the Distress repeat call.
  - Push [◀]/[▶] then push [INFO] to display the transmitted Distress call information.
  - Push [◀]/[▶] then push [PAUSE] to pause the 'Call repeat' mode, push [RESUME] to resume it.



- ⑥ After receiving an acknowledgment call, push [ALARM OFF] then reply using the microphone.



- ➔ A distress alert contains:
- Nature of distress : Selected in step ②.
  - Position information : The latest GPS or manual input position is held for 23.5 hours, or until the power is turned OFF.

When no GPS receiver is connected, and both position and time have been manually programmed, the screen as shown below appears. Edit your latitude and longitude position and UTC time as follows:

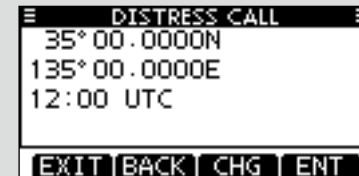

- ➔ Push [CHG], then edit your latitude and longitude position and UTC time.
- Select a desired number using Dial, or [▲]/[▼]/[◀]/[▶].
  - Push [ENT] or Dial to set it.
  - To move the cursor, select either arrow, “←” or “→,” then push [ENT] or Dial.
  - Select N (North latitude) or S (South latitude) when the cursor is on the 'N' or 'S' position.
  - Select W (West longitude) or E (East longitude) when the cursor is on the 'W' or 'E' position.



## 7 DSC OPERATION

### ◇ Distress cancel call

- ① While waiting for an acknowledgment call, push [CANCEL].

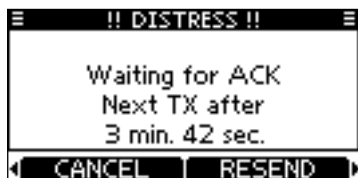

- ② Push [CONTINUE].
- Push [BACK] to return to waiting for an acknowledgement call.



- ③ Push [FINISH].
- Push [EXIT] to return to waiting for an acknowledgement call.



- ④ The Distress cancel call is transmitted.

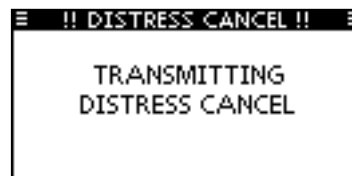

- ⑤ Channel 16 is automatically selected.
- Report your situation using the microphone.
  - After the report, push [EXIT] to return to the normal operating mode.





## ■ Transmitting DSC calls

/// To ensure correct operation of the DSC function, make sure you correctly set the CH70 SQL LEVEL. (p. 63)

### ◇ Transmitting an individual call

The Individual call function allows you to transmit a DSC signal to only a specific station.

- 1 Enter "INDIVIDUAL CALL" in the DSC CALLS menu.

◀[MENU] → ◀DSC Calls → ◀Individual Call  
 (Push [MENU]) (Rotate Dial, then push [ENT].)

- 2 Select the desired preprogrammed individual address, or "Manual Input," using Dial or [▲]/[▼], then push Dial or [ENT].
  - The ID code for the Individual call can be set first. (p. 19)
  - When "Manual Input" is selected, set a desired 9 digit MMSI ID code for the individual you wish to call.

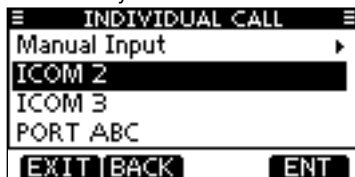

### /// About Manual Inputting:

Enter a desired individual ID in the following way:

- Select a desired number using Dial, or [◀]/[▶].
- Push [ENT] or Dial to set it.
- To move the cursor, select either arrow, "←" or "→," then push [ENT] or Dial.
- The first digit is specified as '0' for a Group ID. If a Group ID is entered, an error beep sounds after pushing [FINISH].
- The first two digits are '0' for any coast station ID.

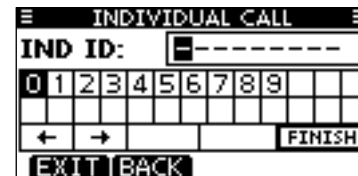

/// **NOTE:** When a coast station is selected in this step, the voice channel is automatically specified by the coast station. Therefore, skip step ③ and go directly to step ④.

- 3 Select a desired intership channel using Dial or [▲](CH)/[▼](CH), then push [ENT].
  - Intership channels are already preset into the transceiver in the recommended order.



☞ Continued on the next page.

## 7 DSC OPERATION

### ◇ Transmitting an Individual call (continued)

#### ④ A confirmation screen appears.

- Confirm the call contents.

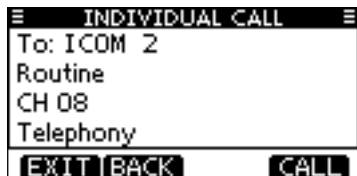

#### ⑤ Push [CALL] to transmit the Individual call.

- If Channel 70 is busy, the transceiver stands by until the channel becomes clear.

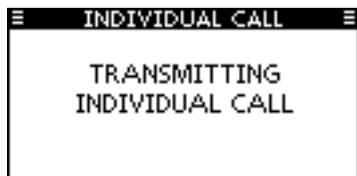

#### ⑥ Standby on Channel 70 until an acknowledgement is received.

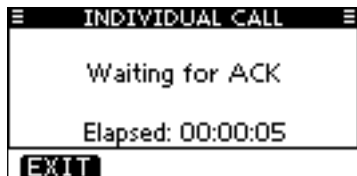

#### ⑦ When the acknowledgement 'Able to comply' is received, beeps sound and the screen below is displayed.



Push [ALARM OFF] to stop the beeps and then select the intership channel specified in step ③.

- A different intership channel will be selected if the station you called cannot use the channel.
- Reply using the microphone. And go to step ⑧.

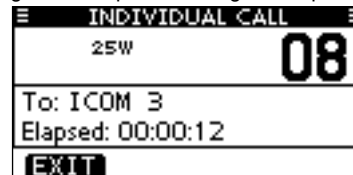

Or, when the acknowledgement 'Unable to comply' is received, beeps sound and the screen below is displayed.

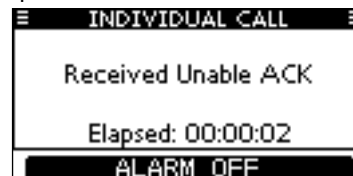

Push [ALARM OFF] to stop the beeps. Then push [EXIT] to return to the operating channel (before you entered the MENU screen).

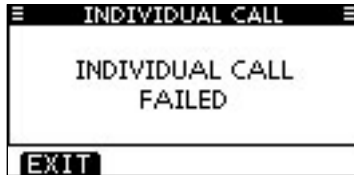

- ⑧ After communicating, push [EXIT] to return to the normal operating mode.

---

✓ **Convenient!**

When the optional MA-500TR CLASS B AIS TRANSPONDER is connected to your transceiver, you can transmit individual DSC calls to selected AIS targets on the transponder without needing to enter the target's MMSI code.

See pages 64 and 65 for more details.

---

## 7 DSC OPERATION

### ◇ Transmitting an Individual Acknowledgement

When receiving an Individual call, you can transmit an acknowledgement ('Able to Comply', 'Propose New Channel' or 'Unable to Comply') by using the on-screen prompts (Quick ACK.) Also, you can send an acknowledgement through the MENU system (Manual ACK.)

#### Quick ACK:

- ① When an Individual call is received, beeps sound and the screen below is displayed.

Push [ALARM OFF] to stop the beeps.



- ② Push [ACK].

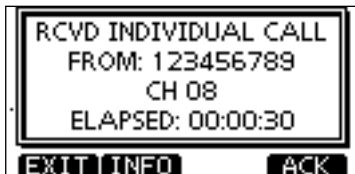

- ③ Select one of three options, then push [ENT].



- Able to Comply : Make an acknowledgment call without any changes.
- Unable to Comply : You cannot make a communication. The Acknowledgement call ('Unable to Comply') can be automatically transmitted, if set. See page 60 for details.
- Propose New Channel : You can make an acknowledgement call, but you specify the intership channel. Select a desired intership channel, using Dial, or [▲](CH)/[▼](CH), then push [ENT].



- ④ The Individual ACK confirmation screen is displayed.  
Push [CALL] to transmit an acknowledgement call.

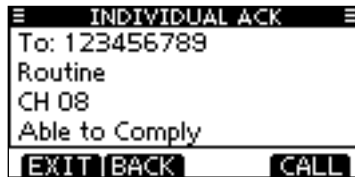

- ⑤ The screens shown below are displayed.

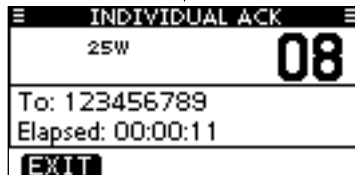
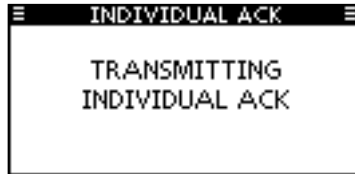

- ⑥ Reply to the call using the microphone.  
⑦ Push [EXIT] to return to the normal operating mode.

**Manual ACK:**

- ① Enter "INDIVIDUAL ACK" in the DSC CALLS menu.

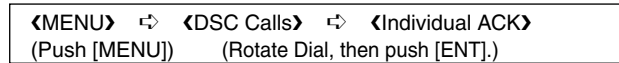

- When no Individual call has been received, "Individual ACK" item will not be displayed.



- ② Select a desired individual address or ID code to reply to, using Dial or [▲]/[▼], then push [ENT].

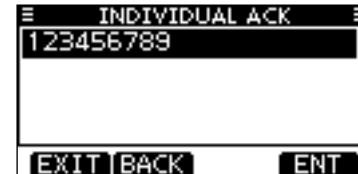

- ③ Perform steps ③ to ⑦, as described in "Quick ACK:," beginning on the previous page.

## 7 DSC OPERATION

### ◇ Transmitting a Group call

The Group call function allows you to transmit a DSC signal to only a specific group.

- 1 Enter "GROUP CALL" in the DSC CALLS menu.

<b>&lt;MENU&gt;</b> ⇄ <b>&lt;DSC Calls&gt;</b> ⇄ <b>&lt;Group Call&gt;</b> (Push [MENU]) (Rotate Dial, then push [ENT].)
---

- 2 Select the desired preprogrammed group address or "Manual Input," using Dial or [▲]/[▼], then push Dial or [ENT].
  - The ID code for the Group call can be set first. (p. 20)
  - When "Manual Input" is selected, set the 8 digit ID code for the group you wish to call.



- 3 Select a desired intership channel using Dial or [▲](CH)/[▼](CH), then push [ENT].
  - Intership channels are already preset into the transceiver in the recommended order.



### **About Manual Inputting:**

Enter a desired group ID in the following way:

- Select a desired number using Dial, or [◀]/[▶].
- Push [ENT] or Dial to set it.
- To move the cursor, select either arrow, "←" or "→," then push [ENT] or Dial.
- The first digit is specified as '0' for a Group ID.
- The first two digits are '0' for any Coast station ID.



- 4 A confirmation screen appears.
  - Confirm the call contents.



- ⑤ Push [CALL] to transmit the Group call.
- If Channel 70 is busy, the transceiver stands by until the channel becomes clear.



- ⑥ After the Group call has been transmitted, the following screen is displayed.



- ⑦ Announce the information using the microphone.
- ⑧ After the announcement, push [EXIT] to return to the normal operating mode.

## 7 DSC OPERATION

### ◇ Transmitting an All Ships call

All ships, that have DSC transceiver, use Channel 70 as their 'listening channel.' When you want to announce a message to these ships within range, use the 'All Ships Call' function.

- ① Enter "ALL SHIPS CALL" in the DSC CALLS menu.

◀MENU> ⇨ ◀DSC Calls> ⇨ ◀All Ships Call>  
(Push [MENU]) (Rotate Dial, then push [ENT].)

- ② Select a desired category, using Dial or [▲]/[▼], then push Dial or [ENT].

- The selectable category may differ, depending on the programmed setting. Ask your dealer for the selectable categories.

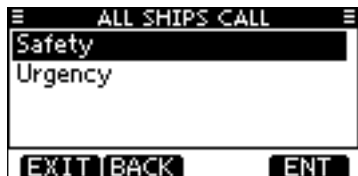

- ③ Select a desired traffic channel, using Dial or [▲]/[▼], then push Dial or [ENT].

- The selected channel is displayed.



- ④ A confirmation screen appears.

- Confirm the call contents.

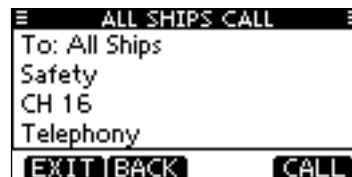

- ⑤ Push [CALL] to transmit the All Ships call.

- If Channel 70 is busy, the transceiver stands by until the channel becomes clear.



- ⑥ After the All Ships call has been transmitted, the following screen is displayed.

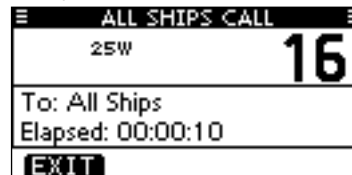

- ⑦ Announce the message using the microphone.

- ⑧ After the announcement, push [EXIT] to return to the normal operating mode.



### ◇ Transmitting a Test call

Testing on the exclusive DSC distress and safety calling channels should be avoided as much as possible. When testing on a distress/safety channel is unavoidable, you should indicate that these are test transmissions.

Normally the test call would require no further communications between the two stations involved.

- 1 Enter "TEST CALL" in the DSC CALLS menu.

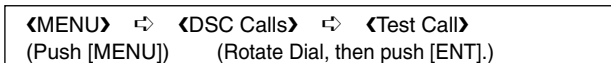

- 2 Select a desired preprogrammed individual address, or "Manual Input," then push Dial or [ENT].
  - The ID code for the Individual call can be set first. (p. 19)
  - When "Manual Input" is selected, set the 9 digit MMSI ID code for the individual you wish to call.

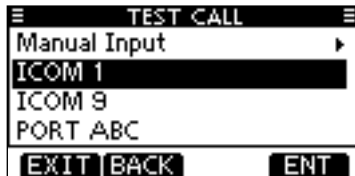

#### About Manual Inputting:

Enter a desired address ID in the following way:

- Select a desired number using Dial, or [◀]/[▶].
- Push [ENT] or Dial to set it.
- To move the cursor, select either arrow, "←" or "→," then push [ENT] or Dial.
- The first digit is specified as '0' for a Group ID. If a Group ID is entered, an error beep sounds after pushing [FINISH].
- The first two digits are '0' for any Coast station ID.

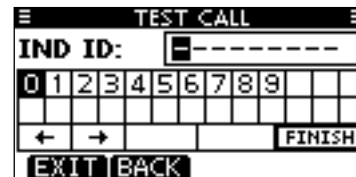

- 3 A confirmation screen appears.
  - Confirm the call contents.

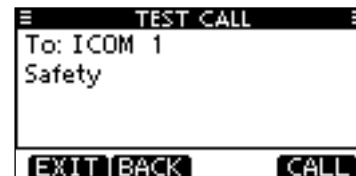

☞ Continued on the next page.

## 7 DSC OPERATION

◇ Transmitting a Test call (continued)

④ Push [CALL] to transmit the Test call.

- If Channel 70 is busy, the transceiver stands by until the channel becomes clear.



⑤ After the Test call has been transmitted, the following screen is displayed.

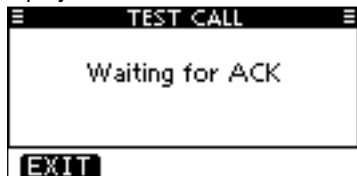

⑥ When the acknowledgement call is received, beeps sound and the following screen is displayed.



⑦ Push [ALARM OFF] to stop the beeps, and then the screen as shown below is displayed.

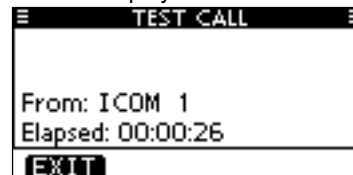

⑧ Push [EXIT] to return to the normal operating mode.

### ◇ Transmitting a Test Acknowledgement call

When the "TEST ACK" in DSC settings is set to 'Auto TX' (p. 60), the transceiver automatically transmits a reply call when receiving a Test call.

#### Quick ACK:

- ① When a Test call is received, beeps sound and the screen shown below is displayed.  
Push [ALARM OFF] to stop the beeps.



- ② Push [ACK].

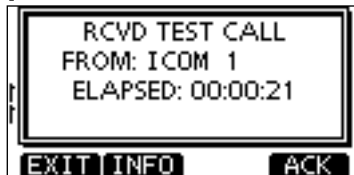

- Push [INFO] to display the Test call information.  
Push [BACK] to return to the previous screen, or push [ACK].



- ③ The Test ACK confirmation screen is displayed.  
Push [CALL] to transmit the acknowledgement call.



- ④ While transmitting the acknowledgement call, the screen shown below is displayed, and then returns to the normal operating mode.



## 7 DSC OPERATION

◇ Transmitting a Test Acknowledgement call (continued)

### Manual ACK:

① Enter "TEST ACK" in the DSC CALLS menu.

◀MENU> ⇄ ▶DSC Calls> ⇄ ▶Test ACK>  
(Push [MENU]) (Rotate Dial, then push [ENT].)

- If no Test call has been received, the "TEST ACK" item will not be displayed.

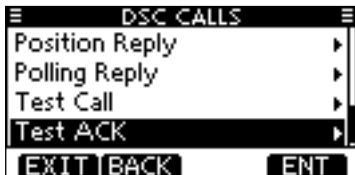

② Select a desired Test call to reply to, using Dial or [▲]/[▼], then push Dial or [ENT].

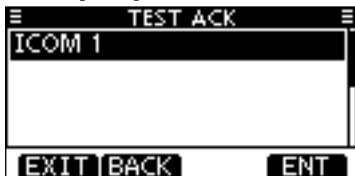

③ The Test ACK confirmation screen is displayed. Push [CALL] to transmit the acknowledgement call.

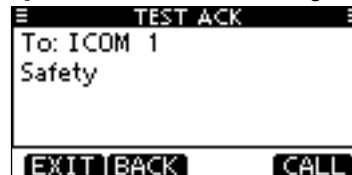

④ While transmitting the acknowledgement call, the screen shown below is displayed, and then returns to the normal operating mode.



### ◇ Transmitting a Position Reply call

Transmit a Position Reply call when a Position Request call is received.

When the “POSITION ACK” in DSC Settings is set to ‘Auto TX’ (p. 60), the transceiver automatically transmits a reply call when receiving a Position Request call.

#### Quick Reply:

- ① When a Position Request call is received, beeps sound and the screen shown below is displayed.  
Push [ALARM OFF] to stop the beeps.



- ② Push [ACK].



- Push [INFO] to display the Position Request call information.  
Push [BACK] to return to the previous screen, or push [ACK].



- ③ The Position Reply confirmation screen is displayed.  
Push [CALL] to transmit the reply call.



- ④ While transmitting the reply call, the screen shown below is displayed, and then returns to the normal operating mode.



## 7 DSC OPERATION

- ◇ Transmitting a Position Reply call (continued)

### Manual Reply:

- ① Enter "POSITION REPLY" in the DSC CALLS menu.

◀MENU▶ ⇄ ▶DSC Calls▶ ⇄ ▶Position Reply▶  
(Push [MENU]) (Rotate Dial, then push [ENT].)

- If no Position Request call has been received, the "POSITION REPLY" item will not be displayed.



- ② Select a desired Position Request call to reply to, using Dial or [▲]/[▼], then push Dial or [ENT].

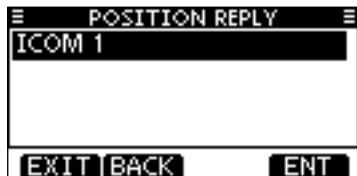

- ③ The Position Reply call confirmation screen is displayed. Push [CALL] to transmit the acknowledgement call.

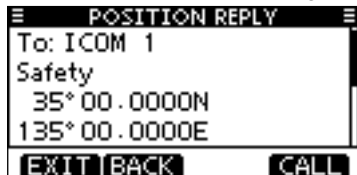

- ④ While transmitting the reply call, the screen shown below is displayed, and then returns to the normal operating mode.



When no GPS receiver is connected, and both position and time have been manually programmed, the screen shown below appears. Edit your latitude and longitude position and UTC time as follows:



- Push [CHG], then edit your latitude and longitude position and UTC time.
- Select a desired number using Dial, or [▲]/[▼]/[◀]/[▶].
  - Push [ENT] or Dial to set it.
  - To move the cursor, select either arrow, "←" or "→," then push [ENT] or Dial.
  - Select N (North latitude) or S (South latitude) when the cursor is on the 'N' or 'S' position.
  - Select W (West longitude) or E (East longitude) when the cursor is on the 'W' or 'E' position.

### ◇ Transmitting a Position Report Reply call

Transmit a Position Report Reply call when a Position Report Request call is received.

#### Quick Reply:

- ① When a Position Report Request call is received, beeps sound and the screen as shown below is displayed.  
Push [ALARM OFF] to stop the beeps.



- ② Push [ACK].



- Push [INFO] to display the Position Report Request call information.  
Push [BACK] to return to the previous screen, or push [ACK].

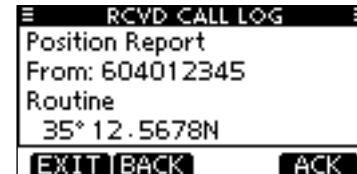

- ③ The Position Report Reply confirmation screen is displayed.  
Push [CALL] to transmit the reply call.



- ④ While transmitting the reply call, the screen shown below is displayed, and then returns to the normal operating mode.



## 7 DSC OPERATION

◇ Transmitting a Position Report Reply call (continued)

### Manual Reply:

- ① Enter "POSITION REPORT REPLY" in the DSC CALLS menu.

◀MENU▶ ⇄ ▶DSC Calls▶ ⇄ ▶Position Report Reply▶  
(Push [MENU]) (Rotate Dial, then push [ENT].)

- If no Position Report Request call has been received, the "POSITION REPORT REPLY" item will not be displayed.



- ② Select a desired Position Report Request call to reply to, using Dial or [▲]/[▼], then push Dial or [ENT].



- ③ The Position Report Reply call confirmation screen is displayed.

Push [CALL] to transmit the acknowledgement call.



- ④ While transmitting the reply call, the screen shown below is displayed, and then returns to the normal operating mode.





### ◇ Transmitting a Polling Reply call

Transmit a Polling Reply call when a Polling Request call is received.

When the “POSITION ACK” in DSC Settings is set to ‘Auto TX’ (p. 60), the transceiver automatically transmits a reply call when receiving a Polling Request call.

#### Quick Reply:

- ① When a Polling Request call is received, beeps sound and the screen as shown below is displayed.  
Push [ALARM OFF] to stop the beeps.

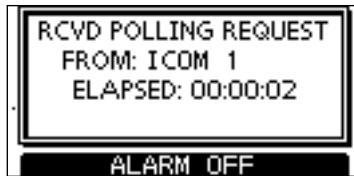

- ② Push [ACK].

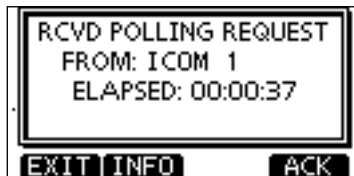

- Push [INFO] to display the Polling Request call information.  
Push [BACK] to return to the previous screen, or push [ACK].



- ③ The Polling Reply confirmation screen is displayed.  
Push [CALL] to transmit the reply call.

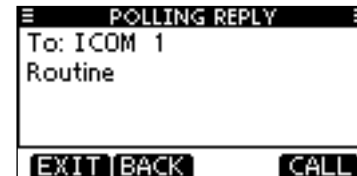

- ④ While transmitting the reply call, the screen shown below is displayed, and then returns to the normal operating mode.



## 7 DSC OPERATION

### Manual Reply:

- ① Enter "POLLING REPLY" in the DSC CALLS menu.

◀MENU▶ ⇄ ◀DSC Calls▶ ⇄ ◀Polling Reply▶  
(Push [MENU]) (Rotate Dial, then push [ENT].)

- If no Polling Request call has been received, the "POLLING REPLY" item will not be displayed.



- ② Select a desired Polling Request call to be replied, using Dial or [▲]/[▼], then push Dial or [ENT].

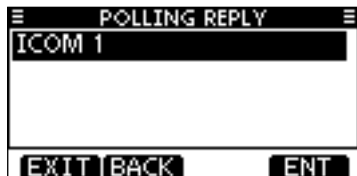

- ③ The Polling Reply call confirmation screen is displayed. Push [CALL] to transmit the acknowledgement call.

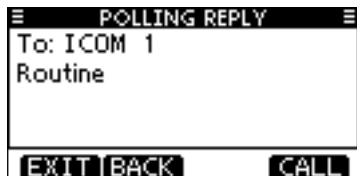

- ④ While transmitting the reply call, the screen shown below is displayed, and then returns to the normal operating mode.



## ■ Receiving DSC calls

### ◇ Receiving a Distress Call

When a Distress Call is received:

- The emergency alarm sounds for 2 minutes.
- “RCVD DISTRESS” pops up and the LCD backlight blinks.

- ① Push [ALARM OFF] to stop the alarm and the blinking backlight.



- ② Push a softkey to select your desired action.



#### [IGN]

- Push to return to the normal operating mode.
  - The transceiver exits the DSC mode.
  - By pushing [PTT], the transceiver also exits the DSC mode.
  - “☑” continues to blink and the Call is stored in the Received Call Log.

#### [INFO]

- Push to display the Received call information. (p. 58)

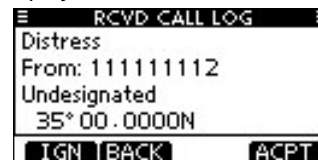

#### [ACPT]

- Push to accept the call.
  - And then, push [CH 16] to switch the operating channel to Channel 16, and then monitor it, as a coast station may require assistance.
  - If you haven't pushed [CH 16] within 10 seconds, the operating channel automatically switches to Channel 16. (p. 61)

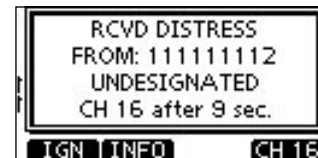

↓ Push

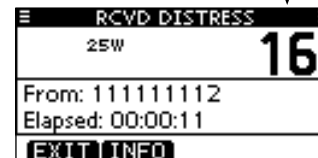

## 7 DSC OPERATION

### ◇ Receiving a Distress Acknowledgement

When a Distress Acknowledgement sent to another ship is received:

- The emergency alarm sounds for 2 minutes.
- “RCVD DISTRESS ACK” pops up and the LCD backlight blinks.

- ① Push [ALARM OFF] to stop the alarm and the blinking backlight.



- ② Push a softkey to select your desired action.

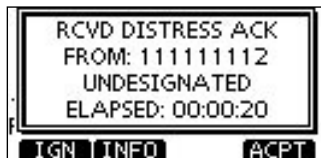

#### [IGN]

- Push to return to the normal operating mode.
  - The transceiver exits the DSC mode.
  - By pushing [PTT], the transceiver also exits the DSC mode.
  - “” continues to blink and the Call is stored in the Received Call Log.

#### [INFO]

- Push to display the Received call information. (p. 58)



#### [ACPT]

- Push to accept the call.  
And then, push [CH 16] to switch the operating channel to Channel 16, and then monitor it, as a coast station may require assistance.
  - If you haven't pushed [CH 16] within 10 seconds, the operating channel automatically switches to Channel 16. (p. 61)

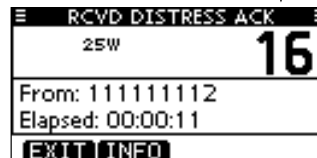

### ◇ Receiving a Distress Relay Call

When a Distress Relay call is received:

- The emergency alarm sounds for 2 minutes.
- “RCVD DISTRESS RELAY” pops up and the LCD backlight blinks.

- ① Push [ALARM OFF] to stop the alarm and the blinking backlight.



- ② Push a softkey to select your desired action.



#### [IGN]

- Push to return to the normal operating mode.
  - The transceiver exits the DSC mode.
  - By pushing [PTT], the transceiver also exits the DSC mode.
  - “” continues to blink and the Call is stored in the Received Call Log.

#### [INFO]

- Push to display the Received call information. (p. 58)

#### [ACPT]

- Push to accept the call.
  - And then, push [CH 16] to switch the operating channel to Channel 16, and then monitor it, as a coast station may require assistance.
  - If you haven't pushed [CH 16] within 10 seconds, the operating channel automatically switches to Channel 16. (p. 61)

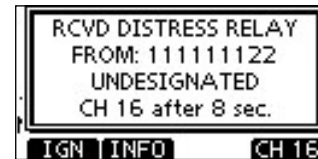

↓ Push

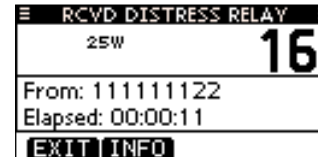

## 7 DSC OPERATION

### ◇ Receiving a Distress Relay Acknowledgement

When a Distress Relay Acknowledgement is received:

- The emergency alarm sounds for 2 minutes.
- “RCVD DIST RELAY ACK” pops up and the LCD backlight blinks.

- ① Push [ALARM OFF] to stop the alarm and the blinking backlight.



- ② Push a softkey to select your desired action.



#### [IGN]

- Push to return to the normal operating mode.
  - The transceiver exits the DSC mode.
  - By pushing [PTT], the transceiver also exits the DSC mode.
  - “✉” continues to blink and the Call is stored in the Received Call Log.

#### [INFO]

- Push to display the Received call information. (p. 58)

#### [ACPT]

- Push to accept the call.

And then, push [CH 16] to switch the operating channel to Channel 16, and then monitor it, as a coast station may require assistance.

- If you haven't pushed [CH 16] within 10 seconds, the operating channel automatically switches to Channel 16. (p. 61)

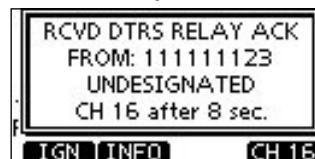

↓ Push

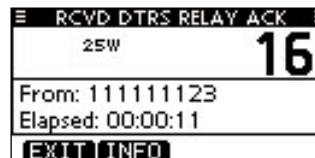

## ◇ Receiving an Individual Call

When an Individual Call is received:

- The alarm sounds for 2 minutes.
- “RCVD INDIVIDUAL CALL” pops up. The LCD backlight may blink for 2 minutes, depending on the received Category.

- ① Push [ALARM OFF] to stop the alarm and the blinking backlight.
  - If [ALARM OFF] is not pushed within 2 minutes, the next screen may appear, depending on the received Category.



- ② Push a softkey to select your desired action.



### [IGN]

- Push to ignore the Call and return to the normal operating mode.
  - The transceiver exits the DSC mode.
  - The Call is stored in the Received Call Log.
  - “✉” continues to blink and the Call is stored in the Received Call Log.

### [INFO]

- Push to display the Received call information. (p. 58)

### [ACK]

- Push to display the “INDIVIDUAL ACK” screen to reply to the Call, and select the channel specified by the calling station for voice communication, depending on your situation. See page 30 for details of the Individual Acknowledgement procedure.

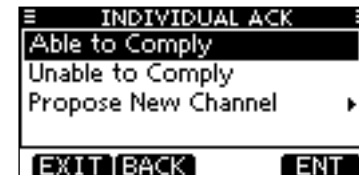

- /// When “INDIVIDUAL ACK” is set to “Auto ACK (Unable),” the transceiver automatically replies to the Call. In that case, both the TX and RX calls are stored in the Transmitted and Received Call Logs.

## 7 DSC OPERATION

### ◇ Receiving a Group Call

When a Group Call is received:

- The alarm sounds for 2 minutes.
- “RCVD GROUP CALL” pops up. The LCD backlight may blink for 2 minutes, depending on the received Category.

- ① Push [ALARM OFF] to stop the alarm and the blinking backlight.
  - If [ALARM OFF] is not pushed within 2 minutes, the next screen may appear, depending on the received Category.



- ② Push a softkey to select your desired action.



### [IGN]

- Push to ignore the Call and return to the normal operating mode.
  - The transceiver exits the DSC mode.
  - “✉” continues to blink and the Call is stored in the Received Call Log.

### [INFO]

- Push to display the Received call information. (p. 58)

### [ACPT]

- Push to monitor the channel specified by the calling station (Example: 08) for an announcement from the calling station.

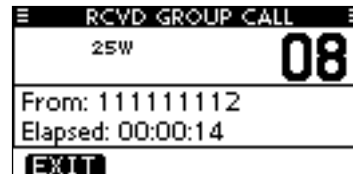



### ◇ Receiving an All Ships Call

When an All Ships Call is received:

- ➔ The alarm sounds for 2 minutes.
- ➔ “RCVD ALL SHIPS CALL” pops up. The LCD backlight may blink for 2 minutes, depending on the received Category.

- ① Push [ALARM OFF] to stop the alarm and the blinking backlight.
  - If [ALARM OFF] is not pushed within 2 minutes, the next screen may appear, depending on the received Category.



- ② Push a softkey to select your desired action.



#### [IGN]

- ➔ Push to ignore the Call and return to the normal operating mode.
  - The transceiver exits the DSC mode.
  - “☑” continues to blink and the Call is stored in the Received Call Log.

#### [INFO]

- ➔ Push to display the Received call information. (p. 58)

#### [ACPT]

- ➔ Push to monitor the channel specified by the calling station (Example: 16) for an announcement from the calling station.

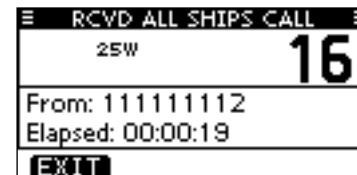

## 7 DSC OPERATION

### ◇ Receiving a Geographical Area Call

When a Geographical Area Call (for the area you are in) is received:

- The alarm sounds for 2 minutes.
- “RCVD GEOGRAPHICAL CALL” pops up. The LCD backlight may blink for 2 minutes, depending on the received Category.

① Push [ALARM OFF] to stop the alarm and the blinking backlight.

- If [ALARM OFF] is not pushed within 2 minutes, the next screen may appear, depending on the received Category.



② Push a softkey to select your desired action.

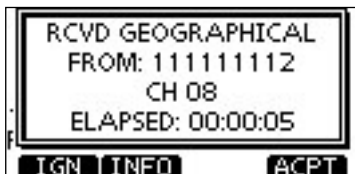

#### [IGN]

- Push to ignore the Call and return to the normal operating mode.
  - The transceiver exits the DSC mode.
  - “✉” continues to blink and the Call is stored in the Received Call Log.

#### [INFO]

- Push to display the Received call information. (p. 58)

#### [ACPT]

- Push to monitor the channel specified by the calling station (Example: 08) for an announcement from the calling station.

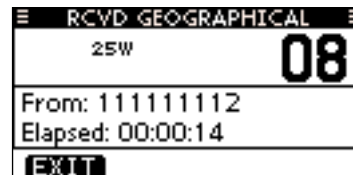

/// When no GPS receiver is connected or if there is a problem with the connected receiver, all Geographical Area Calls are received, regardless of your position.

### ◇ Receiving a Position Request Call

When a Position Request Call is received:

- The alarm sounds for 2 minutes.
- “RCVD POS REQUEST” pops up. The LCD backlight blinks for 2 minutes.

- ① Push [ALARM OFF] to stop the alarm and the blinking backlight.
  - If [ALARM OFF] is not pushed within 2 minutes, the next screen may appear, depending on the received Category.



- ② Push a softkey to select your desired action.



#### [IGN]

- Push to ignore the Call and return to the normal operating mode.
  - The transceiver exits the DSC mode.
  - “✉” continues to blink and the Call is stored in the Received Call Log.

#### [INFO]

- Push to display the Received call information. (p. 58)

#### [ACK]

- Push to display the “POSITION REPLY” screen and send a reply to the Call. (p. 39)



When “POSITION ACK” is set to “Auto TX,” the transceiver automatically replies to the Call. In that case, both the TX and RX calls are stored in the Transmitted and Received Call Logs.

## 7 DSC OPERATION

### ◇ Receiving a Position Report Call

When a Position Report Call is received:

- The alarm sounds for 2 minutes.
- “RCVD POSITION REPORT” pops up. The LCD backlight blinks for 2 minutes.

- ① Push [ALARM OFF] to stop the alarm and the blinking backlight.
  - If [ALARM OFF] is not pushed within 2 minutes, the next screen may appear, depending on the received Category.

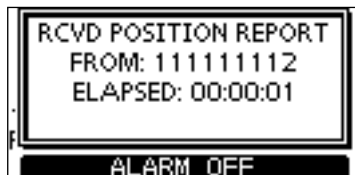

- ② Push a softkey to select your desired action.



### [EXIT]

- Push to ignore the Call and return to the normal operating mode.
  - The transceiver exits the DSC mode.
  - “✉” continues to blink and the Call is stored in the Received Call Log.

### [INFO]

- Push to display the Received call information. (p. 58)

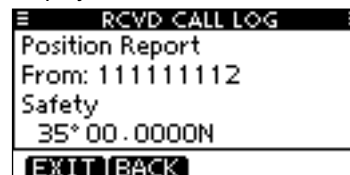

### ◇ Receiving a Polling Request call

When a Polling Request call is received:

- The alarm sounds for 2 minutes.
- “RCVD POLLING REQUEST” pops up. The LCD backlight blinks for 2 minutes.

- ① Push [ALARM OFF] to stop the alarm and the blinking backlight.
  - If [ALARM OFF] is not pushed within 2 minutes, the next screen may appear, depending on the received Category.

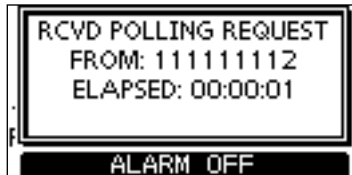

- ② Push a softkey to select your desired action.



#### [IGN]

- Push to ignore the Call and return to the normal operating mode.
  - The transceiver exits the DSC mode.
  - “✉” continues to blink and the Call is stored in the Received Call Log.

#### [INFO]

- Push to display the Received call information. (p. 58)

#### [ACK]

- Push to display the “POLLING REPLY” screen to reply to the Call. (p. 43)

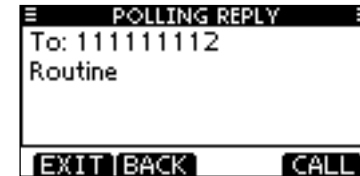

When “POSITION ACK” is set to “Auto TX,” the transceiver automatically replies to the Call. In that case, both the TX and RX calls are stored in the Transmitted and Received Call Logs.

## 7 DSC OPERATION

### ◇ Receiving a Test Call

When a Test Call is received:

- The alarm sounds for 2 minutes.
- “RCVD TEST CALL” pops up. The LCD backlight blinks for 2 minutes.

- ① Push [ALARM OFF] to stop the alarm and the blinking backlight.
  - If [ALARM OFF] is not pushed within 2 minutes, the next screen may appear, depending on the received Category.



- ② Push a softkey to select your desired action.

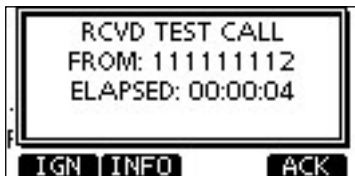

### [IGN]

- Push to ignore the Call and return to the normal operating mode.
  - The transceiver exits the DSC mode.
  - “☑” continues to blink and the Call is stored in the Received Call Log.

### [INFO]

- Push to display the Received call information. (p. 58)

### [ACK]

- Push to display the “TEST ACK” screen to reply to the Call. (p. 37)



When “TEST ACK” is set to “Auto TX,” the transceiver automatically replies to the Call. In that case, both the TX and RX calls are stored in the Transmitted and Received Call Logs.

### ◇ Receiving a Test Acknowledgement Call

When a Test Acknowledgement Call is received:

- ➔ The alarm sounds for 2 minutes.
- ➔ “RCVD TEST ACK” pops up. The LCD backlight blinks for 2 minutes.

- ① Push [ALARM OFF] to stop the alarm and the blinking backlight.
  - If [ALARM OFF] is not pushed within 2 minutes, the next screen may appear, depending on the received Category.



- ② Push a softkey to select your desired action.

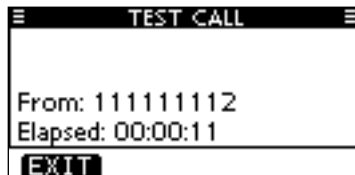

#### [EXIT]

- ➔ Push to return to the normal operating mode.
  - The transceiver exits the DSC mode.
  - “” continues to blink and the Call is stored in the Received Call Log.

## ■ Transmitted Call log

The transceiver automatically stores up to 50 transmitted calls, and the logs can be used as a supplement to your log-book.

- ① Enter “TX CALL LOG” in the DSC CALLS menu.

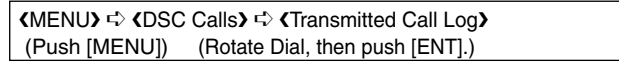

- ② Push [▲] or [▼] to select the desired item, then push [ENT].



- ③ Rotate Dial to scroll the DSC message contents.

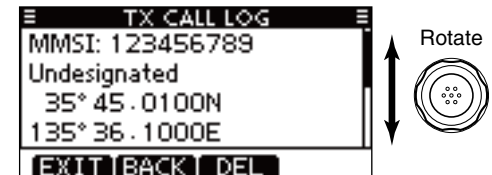

- ④ To delete the displayed DSC message, push [DEL].
  - The confirmation screen appears, then push [OK] to delete.
- ⑤ Push [EXIT] to return to the normal operating mode.

## ■ Received Call log

The transceiver automatically stores up to 50 distress messages and 50 other messages, and they can be used as a supplement to your logbook.

- While in the normal operating mode, “✉” blinks in the upper right corner of the LCD when there is an unread DSC message.

### ◇ Distress message

- ① Push [LOG] to enter “RCVD CALL LOG” in the DSC CALLS menu, or you can enter it through the Menu screen.

◀MENU▶ ⇄ ▶DSC Calls▶ ⇄ ▶Received Call Log▶  
 (Push [MENU]) (Rotate Dial, then push [ENT].)

- ② Push [▲] or [▼] to select “Distress,” then push [ENT].
  - The Distress messages are stored in “Distress.”
  - “✉” appears when there are unread DSC messages.
  - “📁” appears when there are no unread DSC messages.
  - No icon appears when there are no DSC messages.

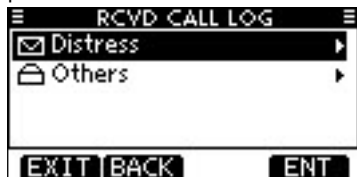

- ③ Push [▲] or [▼] to select the desired item, then push [ENT].
  - The message in the unopened file has not been read.

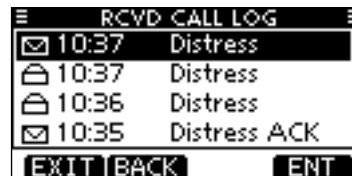

- ④ Rotate Dial to scroll the DSC message contents.



- ⑤ To delete the displayed DSC message, push [DEL].
  - The confirmation screen appears, then push [OK] to delete.
- ⑥ Push [EXIT] to return to the normal operating mode.



◇ Other messages

- ① Push [LOG] to enter “RCVD CALL LOG” in the DSC CALLS menu, or you can enter it through the Menu screen.

◀[MENU] ▶ ◀[DSC Calls] ▶ ◀[Received Call Log] (Push [MENU]) (Rotate Dial, then push [ENT].)

- ② Push [▲] or [▼] to select “Others,” then push [ENT].
  - The messages other than the Distress are stored in “Others.”
  - “✉” appears when there are unread DSC messages.
  - “☰” appears when there are no unread DSC messages.
  - No icon appears when there are no DSC messages.

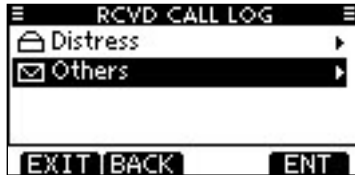

- ③ Push [▲] or [▼] to select the desired item, then push [ENT].
  - The message in the unopened file has not been read.

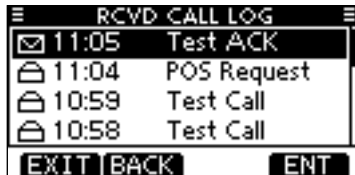

- ④ Rotate Dial to scroll the DSC message contents.
  - The stored message has various information, depending on the DSC call type.



- ⑤ To delete the displayed DSC message, push [DEL].
  - The confirmation screen appears, then push [OK] to delete.
- ⑥ Push [EXIT] to return to the normal operating mode.

## ■ DSC Settings

- ◇ Position Input (See page 22)
- ◇ Add Individual ID/Group ID (See pages 19, 20)
- ◇ Delete Individual ID/Group ID (See page 21)

### ◇ Automatic Acknowledgement

These items set the Automatic Acknowledgement function to “Auto TX” or “Manual TX.”

When an Individual, Position Request, Polling Request or Test Call is received, the transceiver automatically transmits an Individual Acknowledgement, Position Reply, Polling Reply or Test Acknowledgement Call, respectively.

When “INDIVIDUAL ACK” is set to “Auto TX,” the transceiver automatically transmits the Acknowledgment call including “Unable to Comply” (No Reason Given) after receiving the Individual call.

- ① Enter either “INDIVIDUAL ACK,” “POSITION ACK” or “TEST ACK” in the DSC Settings menu.

◀MENU▶ ⇄ ▶DSC Settings▶ ⇄ ▶Individual ACK▶  
(Push [MENU]) (Rotate Dial, then push [ENT].)

◀MENU▶ ⇄ ▶DSC Settings▶ ⇄ ▶Position ACK▶

◀MENU▶ ⇄ ▶DSC Settings▶ ⇄ ▶Test ACK▶

- ② Rotate Dial to select “Auto TX” or “Manual TX,” then push [ENT].
  - Push [BACK] to cancel and return to the DSC Settings menu.

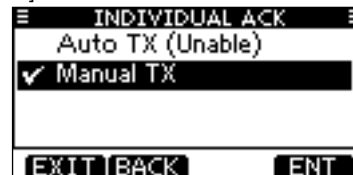

(default)

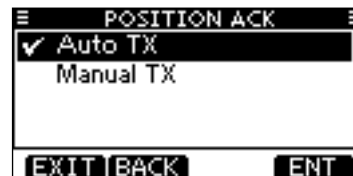

(default)

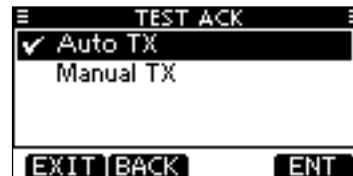

(default)

- ③ Push [EXIT] to return to the normal operating mode.

◇ **Channel 16 Switch function**

By regulation, after receiving a Distress call, the transceiver switches the operating channel to Channel 16. However, when this setting is set to “OFF,” the function enables the transceiver to remain on the operating channel, even after receiving a Distress call.

- ① Enter “CH 16 SWITCH” in the DSC Settings menu.

◀MENU▶ ⇄ ▶DSC Settings▶ ⇄ ▶CH 16 Switch▶  
 (Push [MENU]) (Rotate Dial, then push [ENT].)

- ② Rotate Dial to set the Channel 16 Switch function to “Auto (No Delay),” “10 Second Delay” or “OFF,” then push [ENT].
- Push [BACK] to cancel and return to the DSC Settings menu.

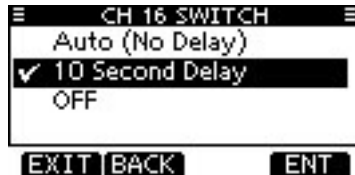

(default)

- Auto (No Delay) : After receiving a Distress call, and [ACPT] is pushed on the confirmation screen, the transceiver immediately switches to Channel 16.
- 10 Second Delay : After receiving a Distress call, and [ACPT] is pushed on the confirmation screen, the transceiver remains on the current operating channel for 10 seconds. After that, the transceiver automatically switches to Channel 16. (default)
- OFF : Even after receiving a Distress call, the transceiver remains on the operating channel.
  - “

③ Push [EXIT] to return to the normal operating mode.

## 7 DSC OPERATION

### ◇ DSC Data Output

Select an option for the DSC Data Output function.

When receiving a DSC call, this function makes the transceiver send the DSC data from its NMEA Output port to a connected device.

- ① Enter "DSC DATA OUTPUT" in the DSC Settings menu.

```
◀MENU▶ ↔ ▶DSC Settings▶ ↔ ▶DSC Data Output▶  
(Push [MENU]) (Rotate Dial, then push [ENT].)
```

- ② Rotate Dial to set the DSC Data Output function to "All Station," "List Station" or "OFF," then push [ENT].

- Push [BACK] to cancel and return to the DSC Settings menu.

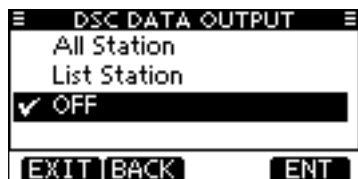

(default)

All Station : Outputs the call from any vessel from the NMEA Output port.

List Station : Outputs the call from any vessels listed on the Individual ID screen.

OFF : Does not output any call to the external equipment.

- ③ Push [EXIT] to return to the normal operating mode.

### ◇ Alarm

Set the Alarm function ON or OFF, depending on the Category or Status.

- ① Enter "ALARM" in the DSC Settings menu.

```
◀MENU▶ ↔ ▶DSC Settings▶ ↔ ▶Alarm▶  
(Push [MENU]) (Rotate Dial, then push [ENT].)
```

- ② Rotate Dial to select the status, then push [ENT].

- Push [BACK] to cancel and return to the DSC Settings menu.
- "Safety," "Routine," "Warning," "Self-Terminate" and "Discrete" are selectable. (default: ON)

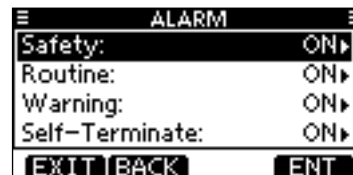

- ③ Rotate Dial to set the Alarm setting to "ON" or "OFF."
- ④ Push [EXIT] to return to the normal operating mode.

### ◇ Channel 70 Squelch level

Set the squelch level on Channel 70.

The transceiver has 11 squelch levels between 1 (loose squelch) and 10 (tight squelch) and OPEN.

OPEN is completely open.

- ① Enter “CH 70 SQL LEVEL” in the DSC Settings menu.

◀MENU▶ ⇄ ▶DSC Settings▶ ⇄ ▶CH 70 SQL Level▶  
 (Push [MENU]) (Rotate Dial, then push [ENT].)

- ② Rotate Dial to adjust the squelch level until the noise just disappears, then push [ENT].
  - Push [BACK] to cancel and return to the DSC Settings menu.

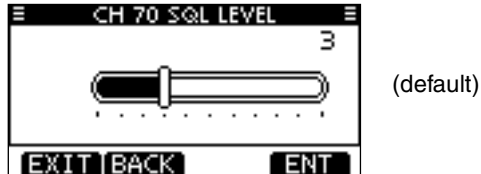

- ③ Push [EXIT] to return to the normal operating mode.

### ◇ DSC Loop Test

The DSC loop test function sends transmit DSC signals to the receive AF circuit to compare and check the TX and RX signals at the AF level.

- ① Enter “DSC LOOP TEST” in the DSC Settings menu.

◀MENU▶ ⇄ ▶DSC Settings▶ ⇄ ▶DSC Loop Test▶  
 (Push [MENU]) (Rotate Dial, then push [ENT].)

- ② Push [ENT] to start the DSC loop test.
  - Push [BACK] to cancel and return to the DSC Settings menu.



- When the transmit DSC and receive DSC signals are matched, “OK” appears.
- ③ Push [EXIT] to return to the normal operating mode.

/// If “NG” appears in step ②, either or both TX and RX DSC circuits has a problem. In that case, you will have to send the transceiver to your nearest dealer for repair.

## ■ Making an Individual call using an AIS transponder

When the optional MA-500TR CLASS B AIS TRANSPONDER is connected to your transceiver, an individual DSC call can be transmitted to a selected AIS target, without needing to enter the target's MMSI code. In this case, the call type is automatically set to Routine.

See page 73 for connecting instructions.

/// To ensure correct operation of the DSC function, make sure you correctly set the CH70 SQL LEVEL. (p. 63)

### Step 1: Transponder's operation

- ① Select a desired AIS target on the plotter, target list or danger list display.
  - You can also go to the next step whenever the detail screen of the AIS target is displayed.
  - Make sure the transceiver is in the normal operating mode. Otherwise, you cannot make an individual DSC call using the transponder.
- ② Push [DSC] to display the voice channel selection screen, and then push [▲] or [▼] to select a desired voice channel\*.
  - Voice channels are already preset into the transponder in recommended order.

\*When a coast station is selected in step ①, a voice channel will be specified by the coast station, therefore you cannot change the channel. The transponder will display "Voice Channel is specified by the Base station," in this case.



Transponder's display



Transceiver's display

- ③ Push [DSC] to transmit an individual DSC call to the AIS target.
  - If Channel 70 is busy, the transceiver stands by until the channel becomes clear.
  - If the transceiver cannot make the call, the transponder will display "DSC Transmission FAILED."

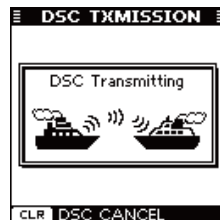

Transponder's display



Transceiver's display

- ④ After making the individual DSC call, the transponder will display “DSC Transmission COMPLETED”
- Push [CLEAR] to return to the screen displayed before you entered the voice channel selection screen in step ②.
  - The transceiver stands by on Channel 70 until an acknowledgement is received.



Transponder's display

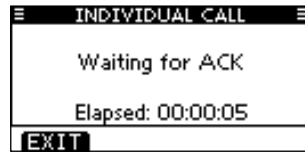

Transceiver's display

**Step 2: Transceiver's operation**

- ⑤ When the acknowledgement is received, beeps sound.
- ➔ If the acknowledgement 'Able to comply' is received, push [ALARM OFF] to stop the beeps, and then select the intership channel specified in step ②.
    - A different intership channel will be selected if the station you called cannot use the channel.
    - To reply, push [PTT] and speak at a normal voice level.
    - You can check the MMSI code or the name, if programmed, of the AIS target on the display.
  - ➔ If the acknowledgement 'Unable to comply' is received, push [ALARM OFF] to stop the beeps, and then return to the operating channel before you entered the MENU screen.

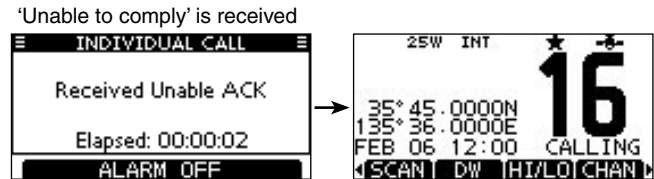
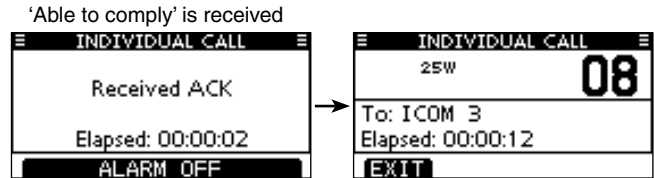

- ⑥ After the communication is finished, push [EXIT] to return to the normal operating mode.

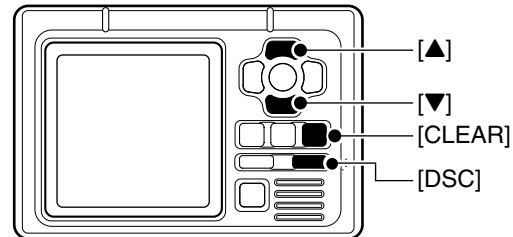

TRANSPONDER

## Menu screen operation

The Menu screen is used for programming infrequently changed values, function settings or sending DSC calls. In addition to this page, see pages 67 through 71 for details.



Menu lists

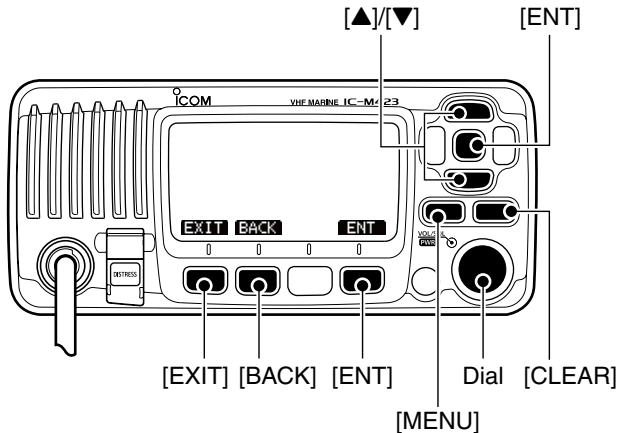

### ◇ Entering the Menu screen and operation

**Example:** Set the channel group to “USA.”

① Push [MENU].



② Rotate Dial or push [▲]/[▼] to select the root item (Radio Settings), and then push [ENT].



- If [▲] or [▼] is continuously held down, the items are sequentially highlighted.

③ Rotate Dial or push [▲]/[▼] to select “CHAN Group,” and then push [ENT].



④ Rotate Dial or push [▲]/[▼] to select “USA,” and then push [ENT] to set it.



- ⑤ Push [EXIT] to exit the Menu screen.
- Push [CLEAR] or [BACK] to return to the previous screen.



## ■ Menu screen items

The Menu screen contains the following items.

### ◇ DSC Calls

Item	Ref.	Item	Ref.
• Individual Call	p. 27	• Transmitted Call Log	p. 57
• Individual ACK*1	p. 31	• Received Call Log	p. 58
• Group Call	p. 32	• Test Call	p. 35
• All Ships Call	p. 34	• Test ACK*1	p. 37
• Distress Call	p. 24		

\*1Appears only after receiving a corresponding call.

### ◇ DSC Settings

Item	Ref.	Item	Ref.
• Position Input*2	p. 22	• CH 16 Switch	p. 61
• Individual ID	p. 19	• DSC Data Output	p. 62
• Group ID	p. 20	• Alarm	p. 62
• Individual ACK	p. 60	• CH 70 SQL Level	p. 63
• Position ACK	p. 60	• DSC Loop Test	p. 63
• Test ACK	p. 60		

\*2Appears only when no GPS information is received.

### ◇ Radio Settings

Item	Ref.	Item	Ref.
• Scan Type	p. 68	• Dual/Tri-Watch	p. 68
• Scan Timer	p. 68	• Channel Group	p. 68

### ◇ Configuration

Item	Ref.	Item	Ref.
• Backlight	p. 69	• UTC Offset	p. 70
• Display Contrast	p. 69	• Inactivity Timer	p. 71
• Key Beep	p. 69	• Remote ID	p. 71
• Key Assignment	p. 69		

### ◇ MMSI/GPS Info

The transceiver shows the programmed MMSI and ATIS\*3 codes and GPS information\*4.

If the code is not programmed, “NO DSC MMSI” or “NO ATIS MMSI”\*3 is displayed.

\*3 Appears only for the Dutch version transceivers.

\*4 When a GPS receiver (NMEA0183 ver. 2.0 or 3.01) is connected.

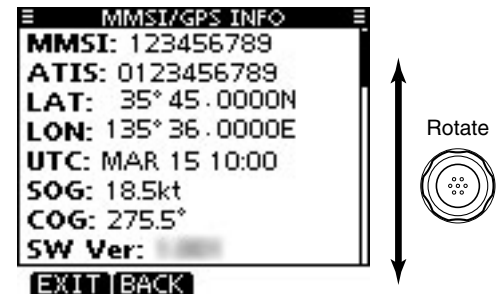

### ■ Radio Settings items

#### ◇ Scan type (Default: Priority Scan)

The transceiver has two scan types; Normal scan and Priority scan. A Normal scan searches all Favorite channels in the selected channel group. A Priority scan sequentially searches all Favorite channels, while monitoring Channel 16.



#### ◇ Scan resume timer (Default: OFF)

The scan resume timer can be selected as a pause (OFF) or timer scan (ON). When OFF is selected, the scan pauses until the signal disappears.

- **Normal scan** When ON is selected, the scan pauses for 5 seconds and then resumes, even if a signal has been received on any channel.
- **Priority scan** When ON is selected, the scan pauses for 5 seconds and then resumes, even if a signal has been received on any channel other than Channel 16.

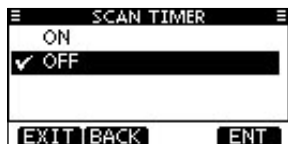

#### ◇ Dual/Tri-watch (Default: Dualwatch)

This item can be selected as Dualwatch or Tri-watch. (p. 18)



#### ◇ Channel Group (Default: INT)

Except for the Europe version, a channel group suitable for your operating area can be selected. Depending on the transceiver version, INT, USA, ATIS or DSC may be selectable.

See page 10 for details.

- The screen below shows the U.K. version.



## ■ Configuration items

### ◇ Backlight (Default: 7)

The function display and keys can be backlit for better visibility under low light conditions.

The backlight can be set to 7 levels and OFF.

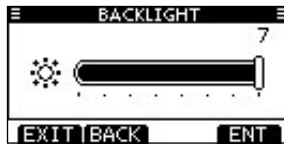

### ◇ Display contrast (Default: 5)

This item adjusts the contrast of the LCD in 8 steps.

Level 1 is the lowest contrast, and level 8 is the highest contrast.

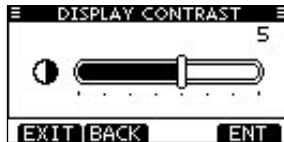

### ◇ Key Beep (Default: ON)

You can turn OFF beep tones for silent operation, or you can turn ON the tones to have confirmation beeps sound when a key is pushed.

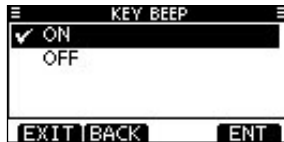

### ◇ Key Assignment

Desired functions can be assigned to Dial and the softkeys.

- ① When the “KEY ASSIGNMENT” screen is displayed, rotate Dial or push [▲]/[▼] to select “Dial” or “Softkeys,” and then push [ENT].

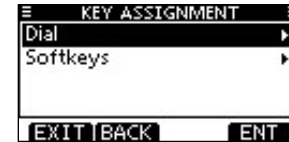

- ② Rotate Dial or push [▲]/[▼] to select the desired position, and then push [ENT].

- To return to the default, select “Set default” and push [ENT].

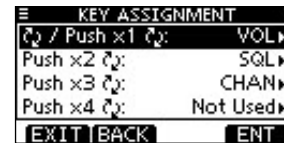

For “Dial” assignment

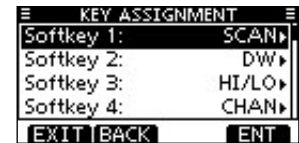

For “Softkeys” assignment

- ③ Rotate Dial or push [▲]/[▼] to select the option, and then push [ENT] to set it.

- “✓” is displayed next to the selected option.

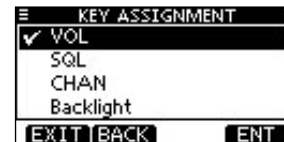

For “Dial” assignment

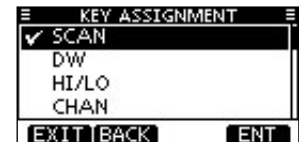

For “Softkeys” assignment

## 8 MENU SCREEN OPERATION

- ④ Push [EXIT] to exit the Menu screen.
- Push [CLEAR] or [BACK] to return to the previous screen.

### • Dial assignment

The Audio volume (VOL), squelch (SQL), channel selection (CHAN) and LCD backlight level (Backlight) functions can be assigned to any one of 4 sequential positions on Dial. Pushing Dial 1 to 4 times sequentially selects the desired function, and rotating Dial adjusts the level or selects a value or number.

### *For example:*

- VOL is assigned the 1st position, and pushing Dial once selects VOL. The VOL screen adjust screen is displayed and rotating Dial adjusts the audio volume.
- CH is assigned to the 3rd position, and pushing Dial three times selects CH. The channel number is displayed and rotating Dial will select the desired channel.

You can assign VOL, SQL, CHAN and Backlight to any one of the 1st, 2nd, 3rd, or 4th sequential positions.

Repeatedly pushing Dial sequentially displays all the functions in the order they are assigned, and skips any functions assigned as Not Used.

### • Softkeys assignment

The desired function can be assigned as the softkey function. The assigned function can be used when its key icon is displayed.

See page 3 for details of the assignable key functions.

### ◇ UTC Offset

(Default: 00:00)

Set the offset time between the UTC (Universal Time Coordinated) and your local time to between -14:00 and +14:00 (in 1 minute steps).



◇ **Inactivity Timer**

Set the inactivity timer to between 1 and 10 minutes (in 1 minute steps) or OFF for the “Not DSC Related” item, and set to between 1 and 15 minutes (in 1 minute steps) or OFF for the “DSC Related” item.

- ① When the “INACTIVITY TIMER” screen is displayed, rotate Dial or push [▲]/[▼] to select “Not DSC Related” or “DSC Related,” and then push [ENT].
- ② Rotate Dial or push [▲]/[▼] to select the option, and then push [ENT] to set it.
  - “✓” is displayed next to the selected option.
- ③ Push [EXIT] to exit the Menu screen.
  - Push [CLEAR] or [BACK] to return to the previous screen.

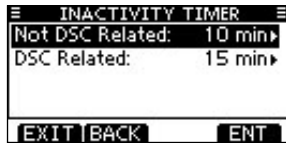

• **Not DSC Related** (Default: 10 min)

When the LCD displays a screen other than the normal operation screen, or one not related to the DSC, and no key operation occurs for this set period, the transceiver automatically returns to the normal operating screen.



• **DSC Related** (Default: 15 min)

When the LCD displays the screen related to the DSC, and no key operation occurs for this set period, except during distress operation, the transceiver automatically returns to the normal operating screen.



◇ **Remote ID** (Default: 15)

Set a Remote ID number to between 1 and 69. The Remote ID is included in the sentence of the Icom original NMEA format.

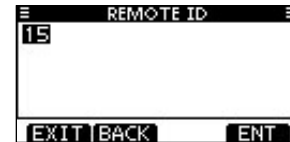

## ■ Connections

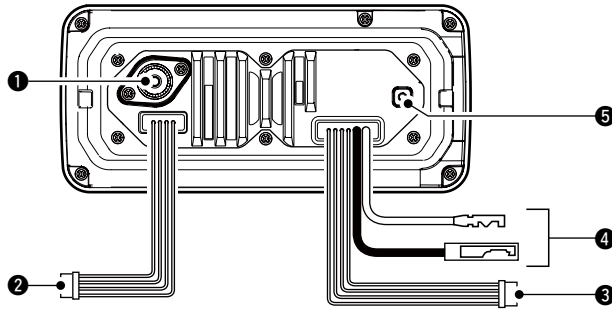

### ❶ ANTENNA CONNECTOR

Connects to a marine VHF antenna cable's PL-259 connector.

**CAUTION:** Transmitting without an antenna may damage the transceiver.

### ❷ NMEA IN/OUT LEADS

#### **Brown: Talker B (Data-L)**

Connects to an NMEA In Negative line of a PC or NMEA0183 ver. 3.01 sentence format DSC, DSE compatible navigation equipment, to receive position data from other ships.

#### **White: Talker A (Data-H)**

Connects to an NMEA In Positive line of a PC or NMEA0183 ver. 3.01 sentence format DSC, DSE compatible navigation equipment, to receive position data from other ships.

#### **Green: Listener B (Data-L)**

Connects to an NMEA Out Negative line of a GPS receiver for position data.

- A NMEA0183 ver. 2.0 or 3.01 RMC, GGA, GNS, GLL and VTG sentence format compatible GPS receiver is required. Ask your dealer about suitable GPS receivers.

#### **Yellow: Listener A (Data-H)**

Connects to an NMEA Out Positive line of a GPS receiver for position data.

- A NMEA0183 ver. 2.0 or 3.01 RMC, GGA, GNS, GLL and VTG sentence format compatible GPS receiver is required. Ask your dealer about suitable GPS receivers.

### ❸ AF OUT LEADS

#### **Blue: External Speaker (+)**

#### **Black: External Speaker (-)**

Connects to an external speaker.

#### **Orange: Data line**

#### **Gray: Data line**

Used only for maintenance purpose.

### **NOTE for NMEA In/Out and AF Out leads:**

The connectors are attached to keep the leads together. Before connecting to a piece of equipment, you should cut the leads to remove the connector.

**4 DC POWER CONNECTOR**

Connects to a 13.8 V DC power source.

**CAUTION:** After connecting the DC power cable, NMEA leads or external speaker leads, cover the connector and leads with an adhesive tape, as shown below, to prevent water seeping into the connection.

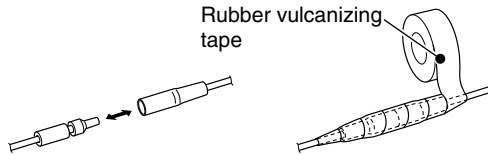

**5 GROUND TERMINAL**

Connects to a vessel ground to prevent electrical shocks and interference from other equipment occurring. Use a PH M3 × 6 screw (not supplied).

**◇ Connect to the MA-500TR**

Connect the transceiver to the high-density D-Sub 15-pin connector of the MA-500TR using the OPC-2014\* cable. After connecting, an Individual DSC call can be made to the AIS target using the transponder without entering the target's MMSI code.

\* The OPC-2014 is supplied with the MA-500TR

- **Listener A (Data-H) lead (Yellow):**  
Connects to lead 3 of the OPC-2014.
- **Listener B (Data-L) lead (Green):**  
Connects to lead 2 of the OPC-2014.
- **Talker A (Data-H) lead (White):**  
Connects to lead 5 of the OPC-2014.
- **Talker B (Data-L) lead (Brown):**  
Connects to lead 4 of the OPC-2014.

## 9 CONNECTIONS AND MAINTENANCE

### ■ Antenna

A key element in the performance of any communication system is the antenna. Ask your dealer about antennas and the best place to mount them.

### ■ Fuse replacement

One fuse is installed in the supplied DC power cable. If the fuse blows or the transceiver stops functioning, track down the source of the problem, repair it, and replace the damaged fuse with a new one of the proper rating.

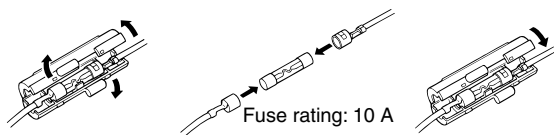

### ■ Supplied accessories

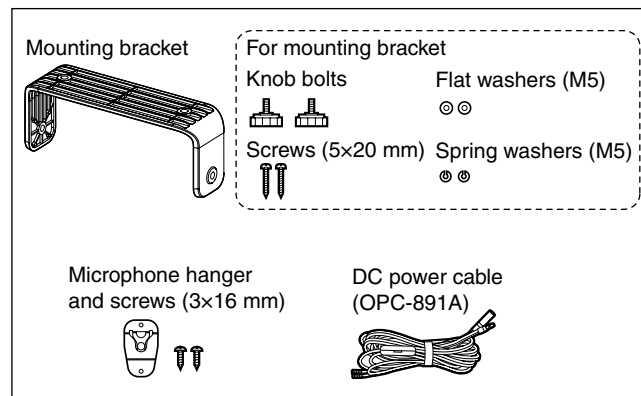

### ■ Cleaning

If the transceiver becomes dusty or dirty, wipe it clean with a soft, dry cloth.



**DO NOT** use harsh solvents such as benzine or alcohol, as they will damage transceiver surfaces.



## ■ Mounting the transceiver

### ◇ Using the supplied mounting bracket

The universal mounting bracket supplied with your transceiver allows overhead or dashboard mounting.

- ① Mount the bracket securely to a surface which is more than 10 mm thick and can support more than 5 kg using the 2 supplied screws (5 × 20 mm).
- ② Attach the transceiver to the bracket so that the face of the transceiver is at 90° to your line of sight when operating it.

/// **KEEP** the transceiver and microphone at least 1 meter away from the vessel's magnetic navigation compass.

/// **NOTE:** Check the installation angle; the function display may not be easy-to-read at some angles.

#### • OVERHEAD MOUNTING

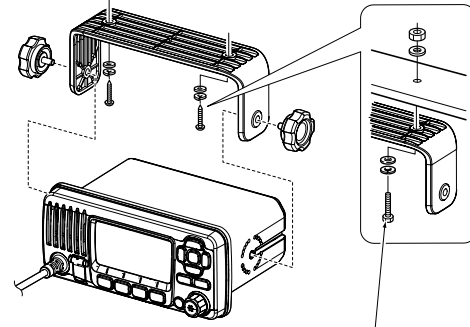

#### • MOUNTING ON THE BOARD

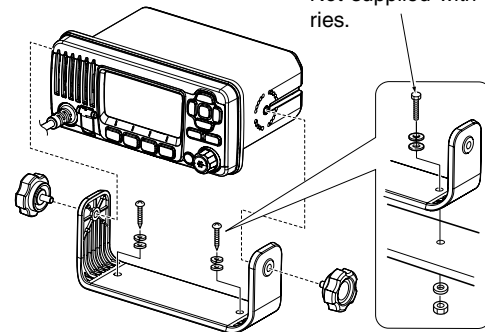

These bolts are shown a mounting example only. Not supplied with accessories.

## 9 CONNECTIONS AND MAINTENANCE

### ■ MB-132 installation

An optional MB-132 FLUSH MOUNT is available for mounting the transceiver to a flat surface, such as an instrument panel.

/// **KEEP** the transceiver and microphone at least 1 meter away from your vessel's magnetic navigation compass.

- ① Using the template on page 81, carefully cut a hole into the instrument panel, or wherever you plan to mount the transceiver.
- ② Slide the transceiver through the hole, as shown below.

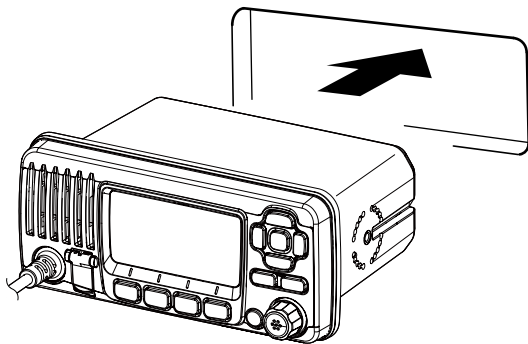

- ③ Attach the clamps on either side of the transceiver with 2 M5 × 8 mm supplied bolts.
  - Make sure that the clamps align parallel to the transceiver body.

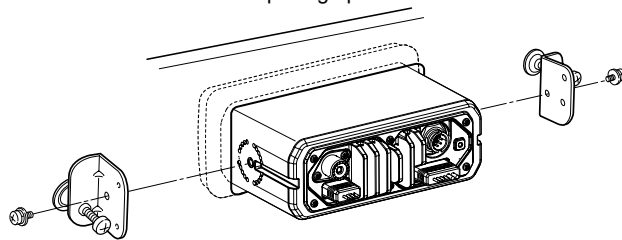

- ④ Tighten the end bolts on the clamps (clockwise) so that the clamps press firmly against the inside of the instrument control panel.
- ⑤ Tighten the locking nuts (counterclockwise) so that the transceiver is securely mounted in position, as shown below.
- ⑥ Connect the antenna and power cable, then return the instrument control panel to its original place.

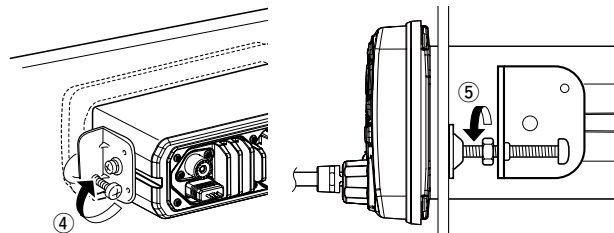

## ■ Specifications

### ◇ General

- Frequency coverage : Tx 156.000–161.450 MHz  
Rx 156.000–163.425 MHz
- Mode : FM (16K0G3E),  
DSC (16K0G2B)
- Channel spacing : 25 kHz
- Operating temp. range : –20°C to +60°C
- Current drain (at 13.8 V) : TX high 5.5 A maximum  
Max. audio 1.5 A maximum
- Power supply requirement : 13.8 V DC nominal  
(negative ground)
- Frequency stability : ±1.5 kHz (–20°C to +60°C)
- Antenna impedance : 50 Ω nominal
- Dimensions (approximately) : 180(W) × 82(H) × 135(D) mm  
(Projections not included)
- Weight (approximately) : 1.2 kg

### ◇ Transmitter

- Output power : 25 W/1 W
- Modulation system : Variable reactance frequency  
modulation
- Max. frequency deviation : ±5.0 kHz
- Spurious emissions : Less than 0.25 μW

### ◇ Receiver

- Receive system : Double conversion  
superheterodyne
- Sensitivity (20 dB SINAD) : –5 dBμ emf (typical)
- Squelch sensitivity : Less than –2 dBμ emf
- Intermodulation rejection ratio : More than 68 dB
- Spurious response rejection ratio:  
More than 70 dB
- Adjacent channel selectivity : More than 70 dB
- Audio output power : More than 2 W at 10% distortion with a 4 Ω load

**All stated specifications are subject to change without notice or obligation.**

## 10 SPECIFICATIONS AND OPTIONS

### ◇ Dimensions

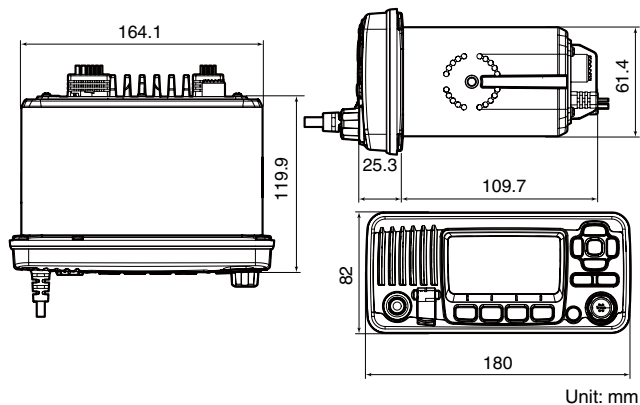

### ■ Options

- **MB-132** FLUSH MOUNT KIT  
To mount the transceiver to a panel.
- **MA-500TR** CLASS B AIS TRANSPONDER  
To transmit individual DSC calls to a selected AIS targets.

Approved Icom optional equipment is designed for optimal performance when used with an Icom transceiver. Icom is not responsible for the destruction or damage to an Icom transceiver in the event the Icom transceiver is used with equipment that is not manufactured or approved by Icom.

# CHANNEL LIST 11

## • International channels

CH	Frequency (MHz)		CH	Frequency (MHz)		CH	Frequency (MHz)		CH	Frequency (MHz)		CH	Frequency (MHz)		CH	Frequency (MHz)	
	Transmit	Receive		Transmit	Receive		Transmit	Receive		Transmit	Receive		Transmit	Receive		Transmit	Receive
01	156.050	160.650	11	156.550	156.550	21	157.050	161.650	61	156.075	160.675	71	156.575	156.575	81	157.075	161.675
02	156.100	160.700	12	156.600	156.600	22	157.100	161.700	62	156.125	160.725	72	156.625	156.625	82	157.125	161.725
03	156.150	160.750	13	156.650	156.650	23	157.150	161.750	63	156.175	160.775	73	156.675	156.675	83	157.175	161.775
04	156.200	160.800	14	156.700	156.700	24	157.200	161.800	64	156.225	160.825	74	156.725	156.725	84	157.225	161.825
05	156.250	160.850	15 <sup>*2</sup>	156.750	156.750	25	157.250	161.850	65	156.275	160.875	75 <sup>*4</sup>	156.775	156.775	85	157.275	161.875
06	156.300	156.300	16	156.800	156.800	26	157.300	161.900	66	156.325	160.925	76 <sup>*4</sup>	156.825	156.825	86	157.325	161.925
07	156.350	160.950	17 <sup>*2</sup>	156.850	156.850	27	157.350	161.950	67	156.375	156.375	77	156.875	156.875	87	157.375	157.375
08	156.400	156.400	18	156.900	161.500	28	157.400	162.000	68	156.425	156.425	78	156.925	161.525	88	157.425	157.425
09	156.450	156.450	19	156.950	161.550	37A <sup>*3</sup>	157.850	157.850	69	156.475	156.475	79	156.975	161.575	P4 <sup>*3</sup>	161.425	161.425
10	156.500	156.500	20	157.000	161.600	60	156.025	160.625	70 <sup>*1</sup>	156.525	156.525	80	157.025	161.625			

\*1 DSC operation only.

\*2 Channels 15 and 17 may also be used for on-board communications provided the effective radiated power does not exceed 1 W, and subject to the national regulations of the administration concerned when these channels are used in its territorial waters.

\*3 UK Marina Channels: M1=37A (157.850 MHz), M2=P4 (161.425 MHz) for U.K. version only

\*4 The output power of channels 75 and 76 are limited to low power (1 W) only. The use of these channels should be restricted to navigation-related communications only and all precautions should be taken to avoid harmful interference to channel 16, e.g. by means geographical separation.

# 11 CHANNEL LIST

• **USA channels** (for U.K. version only)

CH	Frequency (MHz)		CH	Frequency (MHz)		CH	Frequency (MHz)		CH	Frequency (MHz)		CH	Frequency (MHz)		CH	Frequency (MHz)	
	Transmit	Receive		Transmit	Receive		Transmit	Receive		Transmit	Receive		Transmit	Receive		Transmit	Receive
01A	156.050	156.050	12	156.600	156.600	22A	157.100	157.100	64A	156.225	156.225	75* <sup>1</sup>	156.775	156.775	85	157.275	161.875
--	---	---	13* <sup>2</sup>	156.650	156.650	23A	157.150	157.150	65A	156.275	156.275	76* <sup>1</sup>	156.825	156.825	85A	157.275	157.275
03A	156.150	156.150	14	156.700	156.700	24	157.200	161.800	66A	156.325	156.325	77* <sup>1</sup>	156.875	156.875	86	157.325	161.925
--	---	---	15* <sup>2</sup>	156.750	156.750	25	157.250	161.850	67* <sup>2</sup>	156.375	156.375	78A	156.925	156.925	86A	157.325	157.325
05A	156.250	156.250	16	156.800	156.800	26	157.300	161.900	68	156.425	156.425	79A	156.975	156.975	87	157.375	161.975
06	156.300	156.300	17* <sup>1</sup>	156.850	156.850	27	157.350	161.950	69	156.475	156.475	80A	157.025	157.025	87A	157.375	157.375
07A	156.350	156.350	18A	156.900	156.900	28	157.400	162.000	70* <sup>3</sup>	156.525	156.525	81A	157.075	157.075	88	157.425	162.025
08	156.400	156.400	19A	156.950	156.950	37A* <sup>4</sup>	157.850	157.850	71	156.575	156.575	82A	157.125	157.125	88A	157.425	157.425
09	156.450	156.450	20	157.000	161.600	61A	156.075	156.075	72	156.625	156.625	83A	157.175	157.175	P4* <sup>4</sup>	161.425	161.425
10	156.500	156.500	20A	157.000	157.000	--	---	---	73	156.675	156.675	84	157.225	161.825			
11	156.550	156.550	21A	157.050	157.050	63A	156.175	156.175	74	156.725	156.725	84A	157.225	157.225			

\*<sup>1</sup> Low power only.

\*<sup>2</sup> Momentary high power.

\*<sup>3</sup> DSC operation only.

\*<sup>4</sup> UK Marina Channels: M1=37A (157.850 MHz), M2=P4 (161.425 MHz) for U.K. version only

**NOTE:** Simplex channels, 3, 21, 23, 61, 64, 81, 82 and 83 **CANNOT** be lawfully used by the general public in U.S.A. waters.

# TEMPLATE 12

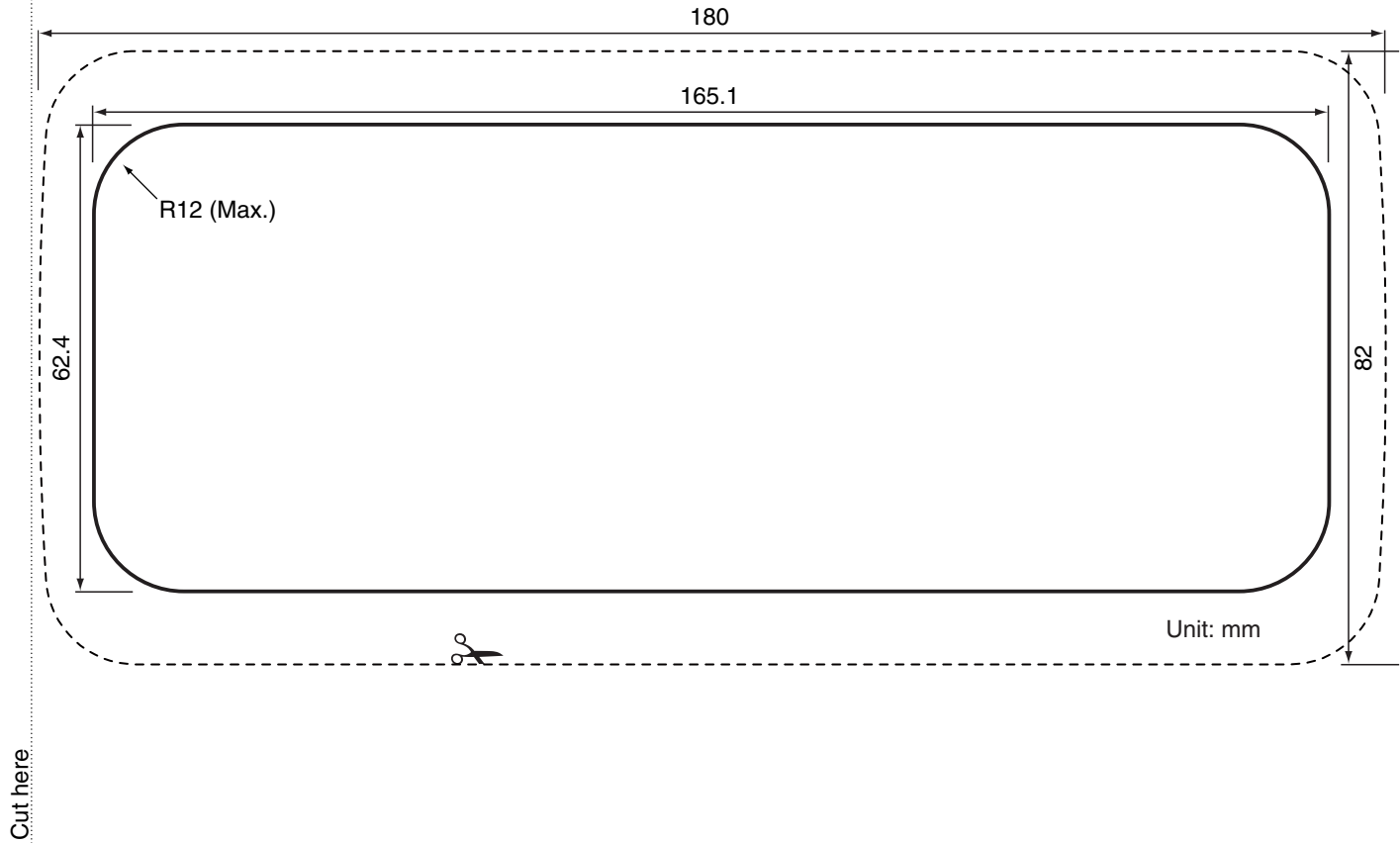

11  
12





# TROUBLE SHOOTING 13

PROBLEM	POSSIBLE CAUSE	SOLUTION	REF.
The transceiver does not turn ON.	<ul style="list-style-type: none"><li>• Bad connection to the power supply.</li></ul>	<ul style="list-style-type: none"><li>• Check the connection to the transceiver and power supply.</li></ul>	p. 72
Little or no sound comes from the speaker.	<ul style="list-style-type: none"><li>• Squelch level is set too high.</li><li>• Volume level is set too low.</li><li>• Speaker has been exposed to water.</li></ul>	<ul style="list-style-type: none"><li>• Set the squelch to the threshold point.</li><li>• Set the volume to a suitable level.</li><li>• Remove the water with the AquaQuake function.</li></ul>	p. 14 p. 14 p. 15
Transmitting is impossible, or high power cannot be selected.	<ul style="list-style-type: none"><li>• Some channels are programmed for low power or receive only by regulations.</li><li>• The output power is set to low.</li></ul>	<ul style="list-style-type: none"><li>• Change channels.</li><li>• Push [HI/LO] to select high power.</li></ul>	pp. 9, 10, 79 p. 11
Scan does not start.	<ul style="list-style-type: none"><li>• Favorite channels are not programmed.</li></ul>	<ul style="list-style-type: none"><li>• Set the desired channels as Favorite channels.</li></ul>	p. 17
No beep sounds.	<ul style="list-style-type: none"><li>• Beep tones are turned OFF.</li></ul>	<ul style="list-style-type: none"><li>• Turn the beep tones ON in the CONFIGURATION menu.</li></ul>	p. 69
Distress calls cannot be transmitted.	<ul style="list-style-type: none"><li>• MMSI (DSC self ID) code is not programmed.</li></ul>	<ul style="list-style-type: none"><li>• Program the MMSI (DSC self ID) code.</li></ul>	p. 7





**Count on us!**

**< Intended Country of Use >**

AT BE CY CZ DK EE  
FI FR DE GR HU IE  
IT LV LT LU MT NL  
PL PT SK SI ES SE  
GB IS LI NO CH BG  
RO TR HR

A-7054D-1EU  
Printed in Japan  
© 2012 Icom Inc.

Printed on recycled paper with soy ink.

**Icom Inc.**

1-1-32 Kamiminami, Hirano-ku, Osaka 547-0003, Japan